

2026

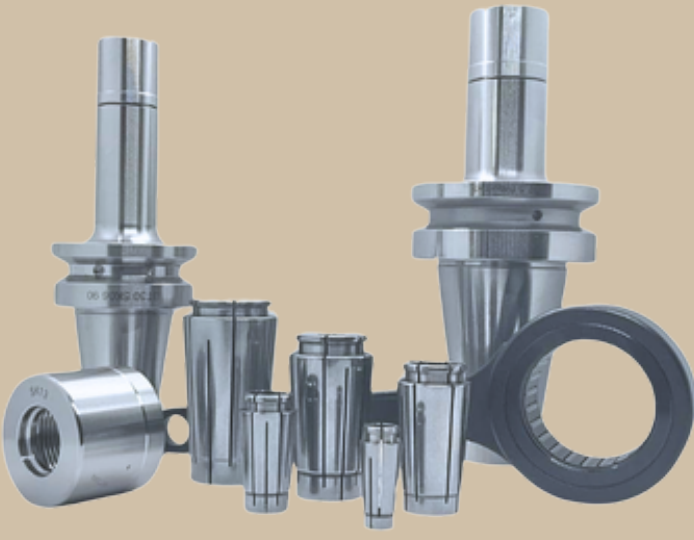

**NEW PRODUCT**  
**YENİ ÜRÜNLER**





62 years of experience...  
62 yıllık tecrübe...

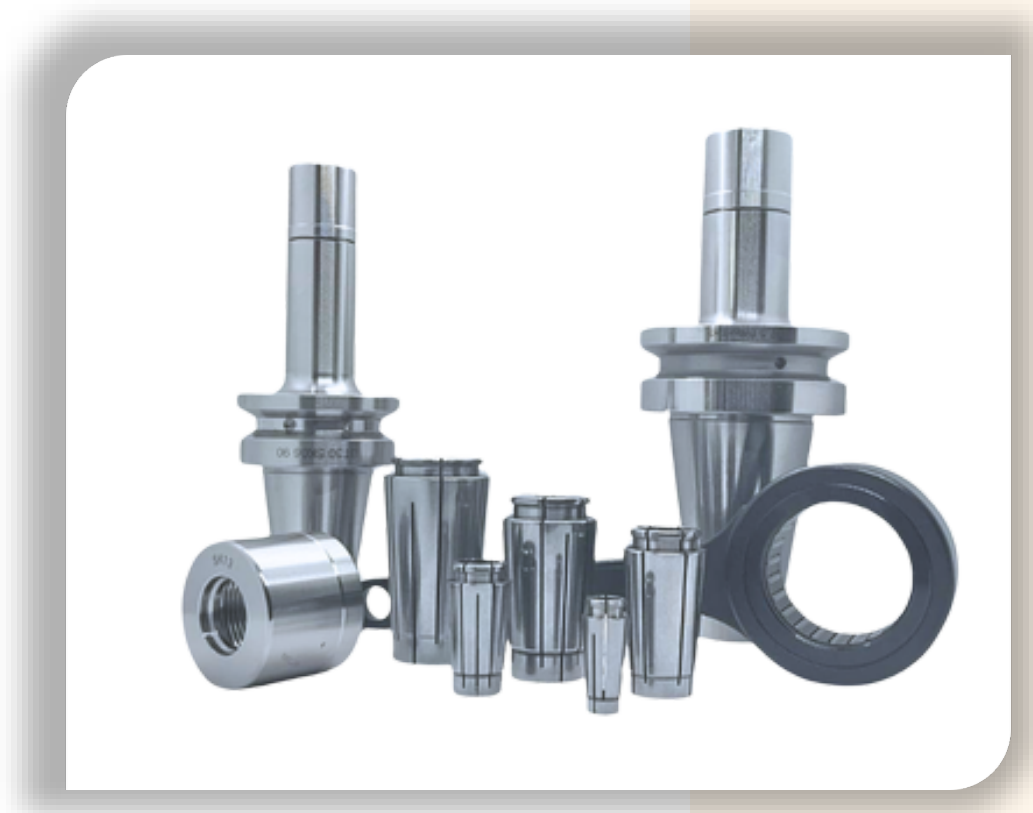

**NEW PRODUCT**  
**YENİ ÜRÜNLER**

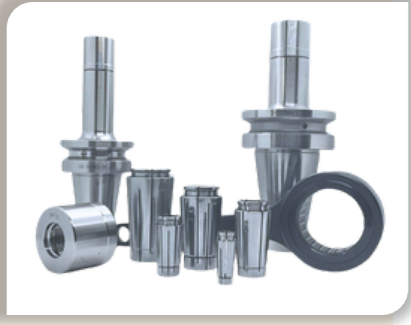

SK TYPE COLLET CHUCKS - COLLETS - LOCKNUTS - SPANNERS 7-11  
SK Hassas Pens Başlıkları - Pensler - Somunlar - Anahtarlar



L200mm ER COLLET CHUCKS 12-13  
L200mm ER Pens Başlıkları



OZ DIN6388 COLLET CHUCKS 14-15  
OZ DIN6388 Pens Başlıkları



FACE MILL ADAPTORS 16-19  
ALINDAN SIKMALI FREZE TUTUCULAR

COMBI SHELL MILL ADAPTORS  
KOMBİNE FREZE TUTUCULAR

20-21



HSK TOOLHODERS  
HSK Takım Tutucular

22-28



STRAIGHT SHANK COLLET CHUCKS  
Silindirik Saplı Pens Tutucuları

29-32



STRAIGHT SHANK ER COLLET HOLDER SETS  
SİLİNDİRİK SAPLI ER PENS TUTUCU SETLERİ

33-36





ER&OZ COLLET SETS WITH CHUCKS  
BAŞLIKLİ ER ve OZ PENS TAKIMLARI

37-40



DOUBLE CONTACT TOOLHOLDERS  
ÇİFT TEMAS YÜZEYLİ ISITMALI TUTUCU

41-42



TOOLHOLDER MACHINEABLE BLANKS  
İşlenebilir Taslak Takım Tutucular (HAMBLOK)

43-44



TAPER REDUCTIONS  
Konik Redüksiyon Adaptörler

45-46

MORSE TAPER SHANK TOOLHOLDERS AND ARBORS 47-52  
Mors Konik Saplı Tutucu ve Kovanlar



LIVE CENTRES - DRILL CHUCKS - SOLID CENTRES  
CYLINDRICAL REDUCTION SLEEVES 53-58  
Döner Puntalar - Matkap Mandrenleri  
Sabit Puntalar - Silindirik Redüksiyon Kovanlar



GUIDE BUSHES WITH CARBIDE BORE 59-61  
YATAKLAMA SÜRÜCÜ PENSLER KARBÜR DELİKLİ



OZ DIN6388 COLLETS 62-63  
OZ DIN6388 Pensler





DIN 6343 EMERGENCY COLLETS  
DIN 6343 Yumuşak İşlenebilir Pensler  
DIN 6343 ADJUSTABLE COLLET STOPS  
DIN 6343 Ayarlı Pens Dayamaları

64-65



TOOLHOLDER ACCESSORIES  
TUTUCU AKSESUARLARI

66-73









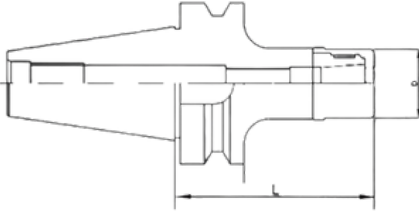









**SK TOOLHOLDERS & COLLETS & LOCKNUTS & SPANNERS**  
**SK Takım Tutucular & Pensler & Anahtarlar & Somunlar**

**JIS B 6339 (MAS403 BT) AD Balanced G2.5**









|                                                                                   | CODE / KOD<br>BT30                                                                             | L  | D    | Collet Type Ø Clamping Range<br>Pens Tipi Ø Sıkma Aralığı | EURO  |
|-----------------------------------------------------------------------------------|------------------------------------------------------------------------------------------------|----|------|-----------------------------------------------------------|-------|
|  | BT30 SK06 90  | 90 | 19.5 | SK06 Ø1-6mm                                               | 37.00 |
|  | BT30 SK10 90  | 90 | 27   | SK10 Ø2-10mm                                              | 37.00 |



|                                                                                     | CODE / KOD<br>BT40                                                                                | L   | D    | Collet Type Ø Clamping Range<br>Pens Tipi Ø Sıkma Aralığı | EURO  |
|-------------------------------------------------------------------------------------|---------------------------------------------------------------------------------------------------|-----|------|-----------------------------------------------------------|-------|
|    | BT40 SK06 90     | 90  | 19.5 | SK06 Ø1-6mm                                               | 37.00 |
|    | BT40 SK10 90     | 90  | 27   | SK10 Ø2-10mm                                              | 37.00 |
|    | BT40 SK10 120    | 120 | 27   | SK10 Ø2-10mm                                              | 44.00 |
|    | BT40 SK13 90     | 90  | 35   | SK13 Ø2-13mm                                              | 37.00 |
|    | BT40 SK13 120    | 120 | 35   | SK13 Ø2-13mm                                              | 44.00 |
|   | BT40 SK16 90    | 90  | 40   | SK16 Ø2-16mm                                              | 37.00 |
|  | BT40 SK16 120  | 120 | 40   | SK16 Ø2-16mm                                              | 44.00 |
|  | BT40 SK20 120  | 120 | 48   | SK20 Ø2-20mm                                              | 44.00 |

|                                                                                     | CODE / KOD<br>BT50                                                                                | L   | D  | Collet Type Ø Clamping Range<br>Pens Tipi Ø Sıkma Aralığı | EURO  |
|-------------------------------------------------------------------------------------|---------------------------------------------------------------------------------------------------|-----|----|-----------------------------------------------------------|-------|
|  | BT50 SK16 120  | 120 | 40 | SK16 Ø2-16mm                                              | 75.00 |
|  | BT50 SK20 120  | 120 | 48 | SK20 Ø2-20mm                                              | 75.00 |

**DIN 69871 (ISO7388 - 1) AD Balanced G2.5**







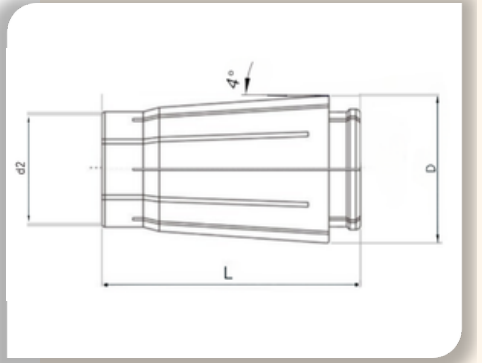

|                                                                                     | CODE / KOD<br>DIN40                                                                                | L   | D  | Collet Type Ø Clamping Range<br>Pens Tipi Ø Sıkma Aralığı | EURO  |
|-------------------------------------------------------------------------------------|----------------------------------------------------------------------------------------------------|-----|----|-----------------------------------------------------------|-------|
|  | DIN40 SK10 90   | 90  | 27 | SK10 Ø2-10mm                                              | 37.00 |
|  | DIN40 SK10 120  | 120 | 27 | SK10 Ø2-10mm                                              | 44.00 |
|  | DIN40 SK16 90   | 90  | 40 | SK16 Ø2-16mm                                              | 37.00 |
|  | DIN40 SK16 120  | 120 | 40 | SK16 Ø2-16mm                                              | 44.00 |

JIS B 6339 (MAS403 BT) AD Balanced G2.5

|                                                                                  | CODE / KOD<br>SK06 |     | Clamping Dia<br>Sıkma Çapı<br>Ø mm | EURO  |
|----------------------------------------------------------------------------------|--------------------|-----|------------------------------------|-------|
|  | SK06010T           | NEW | 1.0 - 0.8                          | 11.00 |
|  | SK06015T           | NEW | 1.5 - 1.3                          | 11.00 |
|  | SK06020T           | NEW | 2.0 - 1.8                          | 9.00  |
|  | SK06025T           | NEW | 2.5 - 2.3                          | 9.00  |
|  | SK06030T           | NEW | 3.0 - 2.8                          | 7.50  |
|  | SK06035T           | NEW | 3.5 - 3.0                          | 7.50  |
|  | SK06040T           | NEW | 4.0 - 3.5                          | 7.50  |
|  | SK06045T           | NEW | 4.5 - 4.0                          | 7.50  |
|  | SK06050T           | NEW | 5.0 - 4.5                          | 7.50  |
|  | SK06055T           | NEW | 5.5 - 5.0                          | 7.50  |
|  | SK06060T           | NEW | 6.0 - 5.5                          | 7.50  |















JIS B 6339 (MAS403 BT) AD Balanced G2.5

|                                                                                    | CODE / KOD<br>SK10 |     | Clamping Dia<br>Sıkma Çapı<br>Ø mm | EURO |
|------------------------------------------------------------------------------------|--------------------|-----|------------------------------------|------|
|  | SK10020T           | NEW | 2.0 - 1.8                          | 9.00 |
|  | SK10030T           | NEW | 3.0 - 2.8                          | 7.50 |
|  | SK10040T           | NEW | 4.0 - 3.5                          | 7.50 |
|  | SK10050T           | NEW | 5.0 - 4.5                          | 7.50 |
|  | SK10060T           | NEW | 6.0 - 5.5                          | 7.50 |
|  | SK10070T           | NEW | 7.0 - 6.5                          | 7.50 |
|  | SK10080T           | NEW | 8.0 - 7.5                          | 7.50 |
|  | SK10090T           | NEW | 9.0 - 8.5                          | 7.50 |
|  | SK10100T           | NEW | 10.0 - 9.5                         | 7.50 |

| SK06 |       |
|------|-------|
| D    | 8.9mm |
| d2   | 7.5mm |
| L    | 25mm  |

JIS B 6339 (MAS403 BT) AD Balanced G2.5

|                                                                                    | CODE / KOD<br>SK13 |     | Clamping Dia<br>Sıkma Çapı<br>Ø mm | EURO |
|------------------------------------------------------------------------------------|--------------------|-----|------------------------------------|------|
|  | SK13020T           | NEW | 2.0 - 1.8                          | 9.00 |
|  | SK13030T           | NEW | 3.0 - 2.8                          | 7.50 |
|  | SK13040T           | NEW | 4.0 - 3.5                          | 7.50 |
|  | SK13050T           | NEW | 5.0 - 4.5                          | 7.50 |
|  | SK13060T           | NEW | 6.0 - 5.5                          | 7.50 |
|  | SK13070T           | NEW | 7.0 - 6.5                          | 7.50 |
|  | SK13080T           | NEW | 8.0 - 7.5                          | 7.50 |
|  | SK13090T           | NEW | 9.0 - 8.5                          | 7.50 |
|  | SK13100T           | NEW | 10.0 - 9.5                         | 7.50 |
|  | SK13110T           | NEW | 11.0 - 10.5                        | 7.50 |
|  | SK13120T           | NEW | 12.0 - 11.5                        | 7.50 |
|  | SK13130T           | NEW | 13.0 - 12.5                        | 7.50 |

| SK10 |        |
|------|--------|
| D    | 13.7mm |
| d2   | 12mm   |
| L    | 25mm   |



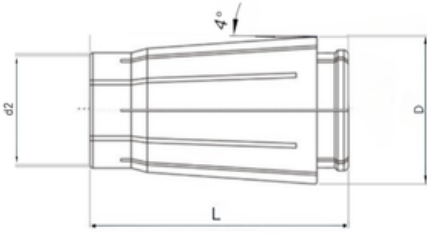





| SK13 |        |
|------|--------|
| D    | 18.5mm |
| d2   | 17mm   |
| L    | 39mm   |





















| SK16 |        |
|------|--------|
| D    | 21.3mm |
| d2   | 18.8mm |
| L    | 45mm   |

| SK20 |        |
|------|--------|
| D    | 26.5mm |
| d2   | 24mm   |
| L    | 50mm   |

### JIS B 6339 (MAS403 BT) AD Balanced G2.5

|                                                                                     | CODE / KOD<br>SK16 | Clamping Dia<br>Sıkma Çapı<br>Ø mm | EURO  |
|-------------------------------------------------------------------------------------|--------------------|------------------------------------|-------|
|    | SK16020T           | 2.0 - 1.8                          | 10.00 |
|    | SK16030T           | 3.0 - 2.8                          | 8.50  |
|    | SK16040T           | 4.0 - 3.5                          | 8.50  |
|    | SK16050T           | 5.0 - 4.5                          | 8.50  |
|    | SK16060T           | 6.0 - 5.5                          | 8.50  |
|    | SK16070T           | 7.0 - 6.5                          | 8.50  |
|    | SK16080T           | 8.0 - 7.5                          | 8.50  |
|    | SK16090T           | 9.0 - 8.5                          | 8.50  |
|    | SK16100T           | 10.0 - 9.5                         | 8.50  |
|    | SK16110T           | 11.0 - 10.5                        | 8.50  |
|    | SK16120T           | 12.0 - 11.5                        | 8.50  |
|    | SK16130T           | 13.0 - 12.5                        | 8.50  |
|    | SK16140T           | 14.0 - 13.5                        | 8.50  |
|  | SK16150T           | 15.0 - 14.5                        | 8.50  |
|  | SK16160T           | 16.0 - 15.5                        | 8.50  |





### JIS B 6339 (MAS403 BT) AD Balanced G2.5

|                                                                                     | CODE / KOD<br>SK20 | Clamping Dia<br>Sıkma Çapı<br>Ø mm | EURO  |
|-------------------------------------------------------------------------------------|--------------------|------------------------------------|-------|
|  | SK20020T           | 2.0 - 1.8                          | 11.00 |
|  | SK20030T           | 3.0 - 2.8                          | 9.50  |
|  | SK20040T           | 4.0 - 3.5                          | 9.50  |
|  | SK20050T           | 5.0 - 4.5                          | 9.50  |
|  | SK20060T           | 6.0 - 5.5                          | 9.50  |
|  | SK20070T           | 7.0 - 6.5                          | 9.50  |
|  | SK20080T           | 8.0 - 7.5                          | 9.50  |
|  | SK20090T           | 9.0 - 8.5                          | 9.50  |
|  | SK20100T           | 10.0 - 9.5                         | 9.50  |
|  | SK20110T           | 11.0 - 10.5                        | 9.50  |
|  | SK20120T           | 12.0 - 11.5                        | 9.50  |
|  | SK20130T           | 13.0 - 12.5                        | 9.50  |
|  | SK20140T           | 14.0 - 13.5                        | 9.50  |
|  | SK20150T           | 15.0 - 14.5                        | 9.50  |
|  | SK20160T           | 16.0 - 15.5                        | 9.50  |
|  | SK20170T           | 17.0 - 16.5                        | 9.50  |
|  | SK20180T           | 18.0 - 17.5                        | 9.50  |
|  | SK20190T           | 19.0 - 18.5                        | 9.50  |
|  | SK20200T           | 20.0 - 19.5                        | 9.50  |

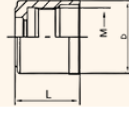
### LOCKNUTS FOR SK COLLET CHUCKS

SK Pens Başlıkları için Somunlar



|                                                                                  | CODE / KOD | SK SIZE / SK Ölçüsü | D     | L  | M       | EURO  |
|----------------------------------------------------------------------------------|------------|---------------------|-------|----|---------|-------|
|  | NSK06      | NEW SK06            | 19.50 | 21 | M15X1   | 7.50  |
|  | NSK10      | NEW SK10            | 27    | 24 | M22X1   | 7.50  |
|  | NSK13      | NEW SK13            | 33    | 27 | M27X1   | 7.50  |
|  | NSK16      | NEW SK16            | 40    | 31 | M32X1.5 | 8.50  |
|  | NSK20      | NEW SK20            | 48    | 30 | M40X1   | 10.00 |



### SPANNERS FOR SK COLLETS CHUCKS

SK Pens Başlıkları için Anahtarlar

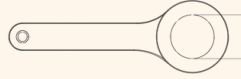



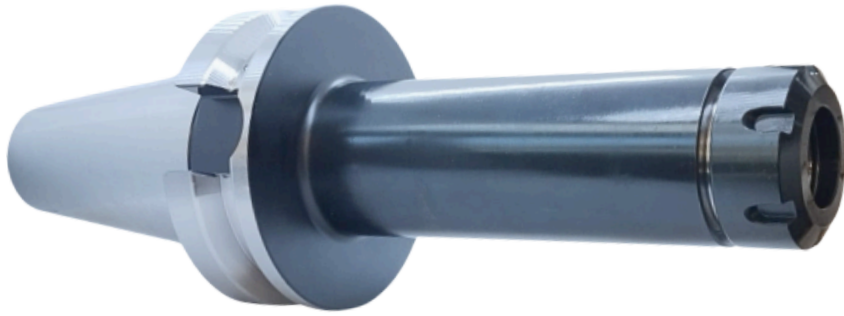

|                                                                                    | CODE / KOD | SK SIZE / SK Ölçüsü | Ø D   | EURO  |
|------------------------------------------------------------------------------------|------------|---------------------|-------|-------|
|  | SPSK06     | NEW SK06            | Ø19.5 | 24.00 |
|  | SPSK10     | NEW SK10            | Ø27   | 26.00 |
|  | SPSK13     | NEW SK13            | Ø33   | 28.00 |
|  | SPSK16     | NEW SK16            | Ø40   | 30.00 |
|  | SPSK20     | NEW SK20            | Ø48   | 36.00 |









**L200mm ER COLLET CHUCKS**  
**L200mm ER Pens Başlıkları**

JIS B 6339 (MAS403 BT) AD&B Balanced G2.5





|                                                                                 | CODE / KOD<br>BT40               | L   | D  | Collet Type and Ø Clamping Range<br>Pens Tipi ve Ø Sıkma Aralığı | EURO  |
|---------------------------------------------------------------------------------|----------------------------------|-----|----|------------------------------------------------------------------|-------|
|  | BT40 ER16 200 <small>NEW</small> | 200 | 28 | ER16 Ø1-12.7mm(1/2")                                             | 72.00 |
|  | BT40 ER25 200 <small>NEW</small> | 200 | 42 | ER25 Ø1-20mm                                                     | 72.00 |
|  | BT40 ER32 200 <small>NEW</small> | 200 | 50 | ER32 Ø1-25mm                                                     | 72.00 |
|  | BT40 ER40 200 <small>NEW</small> | 200 | 63 | ER40 Ø1-32mm                                                     | 75.00 |

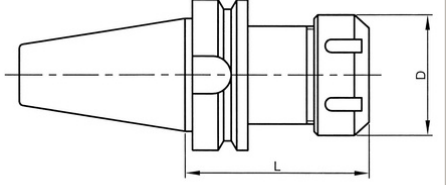





|                                                                                  | CODE / KOD<br>BT50               | L   | D  | Collet Type and Ø Clamping Range<br>Pens Tipi ve Ø Sıkma Aralığı | EURO   |
|----------------------------------------------------------------------------------|----------------------------------|-----|----|------------------------------------------------------------------|--------|
|   | BT50 ER16 200 <small>NEW</small> | 200 | 28 | ER16 Ø1-12.7mm(1/2")                                             | 96.00  |
|   | BT50 ER25 200 <small>NEW</small> | 200 | 42 | ER25 Ø1-20mm                                                     | 96.00  |
|   | BT50 ER32 200 <small>NEW</small> | 200 | 50 | ER32 Ø1-25mm                                                     | 96.00  |
|  | BT50 ER40 200 <small>NEW</small> | 200 | 63 | ER40 Ø1-32mm                                                     | 100.00 |



DIN 69871 (ISO7388-1) AD&B Balanced G2.5

|                                                                                   | CODE / KOD<br>DIN40               | L   | D  | Collet Type and Ø Clamping Range<br>Pens Tipi ve Ø Sıkma Aralığı | EURO  |
|-----------------------------------------------------------------------------------|-----------------------------------|-----|----|------------------------------------------------------------------|-------|
|  | DIN40 ER16 200 <small>NEW</small> | 200 | 28 | ER16 Ø1-12.7mm(1/2")                                             | 72.00 |
|  | DIN40 ER25 200 <small>NEW</small> | 200 | 42 | ER25 Ø1-20mm                                                     | 72.00 |
|  | DIN40 ER32 200 <small>NEW</small> | 200 | 50 | ER32 Ø1-25mm                                                     | 72.00 |
|  | DIN40 ER40 200 <small>NEW</small> | 200 | 63 | ER40 Ø1-32mm                                                     | 75.00 |



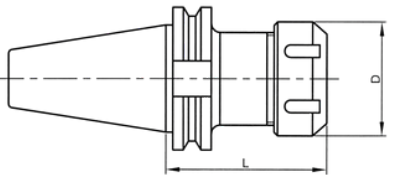

|                                                                                   | CODE / KOD<br>DIN50               | L   | D  | Collet Type and Ø Clamping Range<br>Pens Tipi ve Ø Sıkma Aralığı | EURO   |
|-----------------------------------------------------------------------------------|-----------------------------------|-----|----|------------------------------------------------------------------|--------|
|  | DIN50 ER16 200 <small>NEW</small> | 200 | 28 | ER16 Ø1-12.7mm(1/2")                                             | 96.00  |
|  | DIN50 ER25 200 <small>NEW</small> | 200 | 42 | ER25 Ø1-20mm                                                     | 96.00  |
|  | DIN50 ER32 200 <small>NEW</small> | 200 | 50 | ER32 Ø1-25mm                                                     | 96.00  |
|  | DIN50 ER40 200 <small>NEW</small> | 200 | 63 | ER40 Ø1-32mm                                                     | 100.00 |







**OZ DIN6388 COLLET CHUCKS**  
**OZ DIN6388 Pens Başlıkları**

**OZ DIN6388 COLLET CHUCKS**  
**OZ DIN6388 Pens Başlıkları**

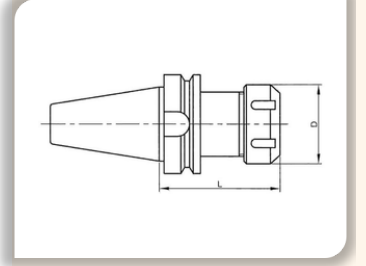
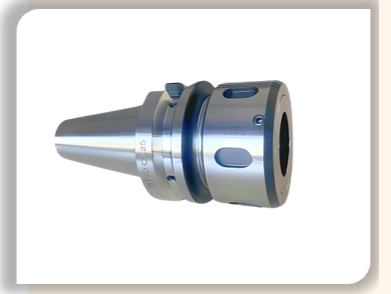
|                                                                                 | CODE / KOD<br>BT | L   | D  | Collet Type and Ø Clamping Range<br>Pens Tipi ve Ø Sıkma Aralığı | EURO  |
|---------------------------------------------------------------------------------|------------------|-----|----|------------------------------------------------------------------|-------|
|  | BT40 OZ25        | 70  | 60 | OZ25 Ø2-30mm                                                     | 42.00 |
|  | BT40 OZ32        | 80  | 72 | OZ32 Ø4-32mm                                                     | 54.00 |
|  | BT50 OZ32        | 100 | 72 | OZ32 Ø4-32mm                                                     | 73.00 |



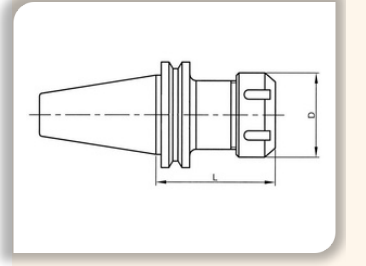

**DIN 69871 (ISO7388-1) OZ DIN6388 COLLET CHUCK**  
**PENS BAŞLIĞI OZ DIN6388**

|                                                                                   | CODE / KOD<br>DIN | L  | D  | Collet Type and Ø Clamping Range<br>Pens Tipi ve Ø Sıkma Aralığı | EURO  |
|-----------------------------------------------------------------------------------|-------------------|----|----|------------------------------------------------------------------|-------|
|  | DIN40 OZ25        | 70 | 60 | OZ25 Ø2-30mm                                                     | 42.00 |
|  | DIN40 OZ32        | 80 | 72 | OZ32 Ø4-32mm                                                     | 54.00 |



**DIN 2080 ISO DIN6388 (OZ) COLLET CHUCK**  
**PENS BAŞLIĞI**



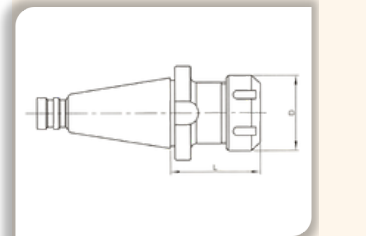

|                                                                                    | CODE / KOD<br>ISO | L  | D  | Collet Type and Ø Clamping Range<br>Pens Tipi ve Ø Sıkma Aralığı | EURO  |
|------------------------------------------------------------------------------------|-------------------|----|----|------------------------------------------------------------------|-------|
|  | ISO40 OZ25        | 70 | 60 | OZ25 Ø2-30mm                                                     | 42.00 |
|  | ISO40 OZ32        | 80 | 72 | OZ32 Ø4-32mm                                                     | 54.00 |
|  | ISO50 OZ32        | 80 | 72 | OZ32 Ø4-32mm                                                     | 73.00 |











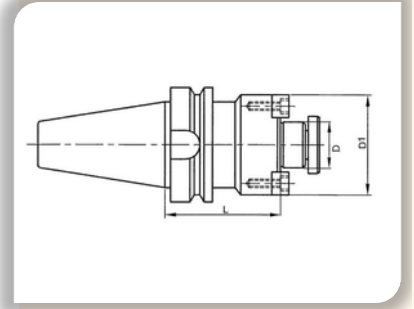















**FACE MILL ADAPTORS  
ALINDAN SIKMALI FREZE TUTUCULAR**

JIS B 6339 (MAS403 BT30) AD&B Balanced G6.3

|                                                                                  | CODE / KOD<br>BT30 | D  | D1 | L  | EURO  |
|----------------------------------------------------------------------------------|--------------------|----|----|----|-------|
|  | BT30 FM16          | 16 | 38 | 40 | 31.00 |
|  | BT30 FM22          | 22 | 48 | 40 | 31.00 |
|  | BT30 FM27          | 27 | 58 | 40 | 31.00 |
|  | BT30 FM32          | 32 | 78 | 50 | 33.00 |







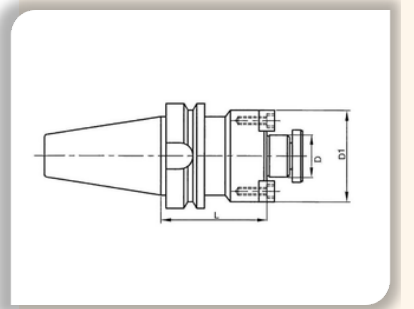



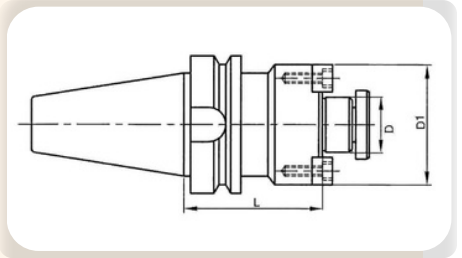







JIS B 6339 (MAS403 BT40) AD&B Balanced G6.3

|                                                                                    | CODE / KOD<br>BT40                                                                                | D  | D1 | L   | EURO  |
|------------------------------------------------------------------------------------|---------------------------------------------------------------------------------------------------|----|----|-----|-------|
|  | BT40 FM16                                                                                         | 16 | 38 | 40  | 31.00 |
|  | BT40 FM16 100                                                                                     | 16 | 38 | 100 | 41.00 |
|  | BT40 FM16 160                                                                                     | 16 | 38 | 160 | 62.00 |
|  | BT40 FM16 200  | 16 | 38 | 200 | 82.00 |
|  | BT40 FM22                                                                                         | 22 | 48 | 45  | 31.00 |
|  | BT40 FM22 100                                                                                     | 22 | 48 | 100 | 41.00 |
|  | BT40 FM22 160                                                                                     | 22 | 48 | 160 | 62.00 |
|  | BT40 FM22 200  | 22 | 48 | 200 | 82.00 |
|  | BT40 FM27                                                                                         | 27 | 58 | 45  | 32.00 |
|  | BT40 FM27 100                                                                                     | 27 | 58 | 100 | 42.00 |
|  | BT40 FM27 160                                                                                     | 27 | 58 | 160 | 63.00 |
|  | BT40 FM27 200  | 27 | 58 | 200 | 83.00 |
|  | BT40 FM32                                                                                         | 32 | 78 | 50  | 34.00 |
|  | BT40 FM32 100                                                                                     | 32 | 78 | 100 | 44.00 |
|  | BT40 FM32 160                                                                                     | 32 | 78 | 160 | 65.00 |
|  | BT40 FM40                                                                                         | 40 | 88 | 55  | 37.00 |
|  | BT40 FM40 100                                                                                     | 40 | 88 | 100 | 47.00 |
|  | BT40 FM40 160  | 40 | 88 | 160 | 68.00 |







JIS B 6339 (MAS403 BT50) AD&B Balanced G6.3

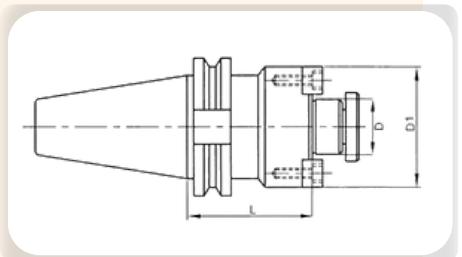

|                                                                                     | CODE / KOD<br>BT50 | D  | D1 | L   | EURO   |
|-------------------------------------------------------------------------------------|--------------------|----|----|-----|--------|
|    | BT50 FM16          | 16 | 38 | 55  | 55.00  |
|    | BT50 FM16 100      | 16 | 38 | 100 | 65.00  |
|    | BT50 FM16 160      | 16 | 38 | 160 | 85.00  |
|    | BT50 FM22          | 22 | 48 | 55  | 55.00  |
|    | BT50 FM22 100      | 22 | 48 | 100 | 65.00  |
|    | BT50 FM22 160      | 22 | 48 | 160 | 85.00  |
|    | BT50 FM22 200      | 22 | 48 | 200 | 104.00 |
|    | BT50 FM27          | 27 | 58 | 55  | 56.00  |
|    | BT50 FM27 100      | 27 | 58 | 100 | 66.00  |
|    | BT50 FM27 160      | 27 | 58 | 160 | 86.00  |
|   | BT50 FM27 200      | 27 | 58 | 200 | 105.00 |
|  | BT50 FM32          | 32 | 78 | 55  | 58.00  |
|  | BT50 FM32 100      | 32 | 78 | 100 | 68.00  |
|  | BT50 FM32 160      | 32 | 78 | 160 | 88.00  |
|  | BT50 FM32 200      | 32 | 78 | 200 | 107.00 |
|  | BT50 FM40          | 40 | 88 | 55  | 60.00  |
|  | BT50 FM40 100      | 40 | 88 | 100 | 70.00  |
|  | BT50 FM40 160      | 40 | 88 | 160 | 90.00  |

DIN30 69871 (ISO7388-1) AD&B Balanced G6.3









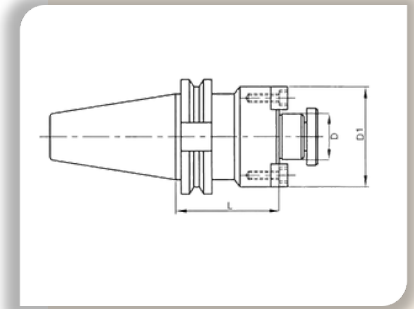











|                                                                                     | CODE / KOD<br>DIN30 | D  | D1 | L  | EURO  |
|-------------------------------------------------------------------------------------|---------------------|----|----|----|-------|
|  | DIN30 FM16          | 16 | 38 | 40 | 31.00 |
|  | DIN30 FM22          | 22 | 48 | 40 | 31.00 |
|  | DIN30 FM27          | 27 | 58 | 40 | 31.00 |
|  | DIN30 FM32          | 32 | 78 | 50 | 33.00 |

**DIN40 69871 (ISO7388-1) AD&B Balanced G6.3**

|                                                                                   | CODE / KOD<br>DIN40               | D  | D1 | L   | EURO  |
|-----------------------------------------------------------------------------------|-----------------------------------|----|----|-----|-------|
|    | DIN40 FM16                        | 16 | 38 | 35  | 31.00 |
|    | DIN40 FM16 100                    | 16 | 38 | 100 | 41.00 |
|    | DIN40 FM16 160                    | 16 | 38 | 160 | 62.00 |
|    | DIN40 FM16 200 <small>NEW</small> | 16 | 38 | 200 | 82.00 |
|    | DIN40 FM22                        | 22 | 48 | 35  | 31.00 |
|    | DIN40 FM22 100                    | 22 | 48 | 100 | 41.00 |
|    | DIN40 FM22 160                    | 22 | 48 | 160 | 62.00 |
|    | DIN40 FM22 200 <small>NEW</small> | 22 | 48 | 200 | 82.00 |
|    | DIN40 FM27                        | 27 | 58 | 40  | 32.00 |
|    | DIN40 FM27 100                    | 27 | 58 | 100 | 42.00 |
|    | DIN40 FM27 160                    | 27 | 58 | 160 | 63.00 |
|    | DIN40 FM27 200 <small>NEW</small> | 27 | 58 | 200 | 83.00 |
|    | DIN40 FM32                        | 32 | 78 | 50  | 34.00 |
|   | DIN40 FM32 100                    | 32 | 78 | 100 | 44.00 |
|  | DIN40 FM32 160                    | 32 | 78 | 160 | 65.00 |
|  | DIN40 FM40                        | 40 | 88 | 50  | 37.00 |
|  | DIN40 FM40 100                    | 40 | 88 | 100 | 47.00 |
|  | DIN40 FM40 160 <small>NEW</small> | 40 | 88 | 160 | 68.00 |



**DIN50 69871 (ISO7388-1) AD&B Balanced G6.3**



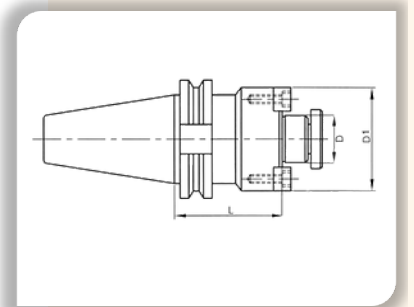

|                                                                                   | CODE / KOD<br>DIN50               | D  | D1 | L   | EURO   |
|-----------------------------------------------------------------------------------|-----------------------------------|----|----|-----|--------|
|  | DIN50 FM16                        | 16 | 38 | 45  | 55.00  |
|  | DIN50 FM16 100                    | 16 | 38 | 100 | 65.00  |
|  | DIN50 FM16 160 <small>NEW</small> | 16 | 38 | 160 | 85.00  |
|  | DIN50 FM22                        | 22 | 48 | 45  | 55.00  |
|  | DIN50 FM22 100                    | 22 | 48 | 100 | 65.00  |
|  | DIN50 FM22 160 <small>NEW</small> | 22 | 48 | 160 | 85.00  |
|  | DIN50 FM22 200 <small>NEW</small> | 22 | 48 | 200 | 104.00 |
|  | DIN50 FM27                        | 27 | 58 | 45  | 56.00  |
|  | DIN50 FM27 100                    | 27 | 58 | 100 | 66.00  |
|  | DIN50 FM27 160 <small>NEW</small> | 27 | 58 | 160 | 86.00  |
|  | DIN50 FM27 200 <small>NEW</small> | 27 | 58 | 200 | 105.00 |
|  | DIN50 FM32                        | 32 | 78 | 55  | 58.00  |
|  | DIN50 FM32 100                    | 32 | 78 | 100 | 68.00  |
|  | DIN50 FM32 160 <small>NEW</small> | 32 | 78 | 160 | 88.00  |
|  | DIN50 FM32 200 <small>NEW</small> | 32 | 78 | 200 | 107.00 |
|  | DIN50 FM40                        | 40 | 88 | 55  | 60.00  |
|  | DIN50 FM40 100                    | 40 | 88 | 100 | 70.00  |
|  | DIN50 FM40 160 <small>NEW</small> | 40 | 88 | 160 | 90.00  |













**COMBI SHELL MILL ADAPTORS  
KOMBİNE FREZE TUTUCULAR**

JIS B 6339 (MAS403 BT40) AD&B Balanced G6.3

|                                                                                 | CODE / KOD<br>BT40 | D  | D1 | L  | EURO  |
|---------------------------------------------------------------------------------|--------------------|----|----|----|-------|
|  | BT40 CM16          | 16 | 32 | 55 | 35.00 |
|  | BT40 CM22          | 22 | 40 | 55 | 35.00 |
|  | BT40 CM27          | 27 | 48 | 55 | 36.00 |
|  | BT40 CM32          | 32 | 58 | 60 | 38.00 |
|  | BT40 CM40          | 40 | 70 | 60 | 41.00 |





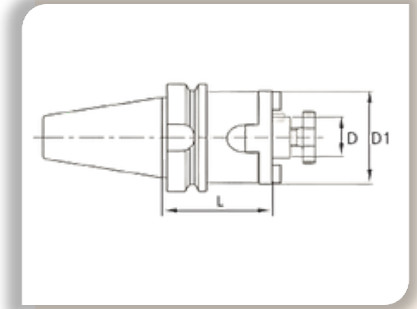

JIS B 6339 (MAS403 BT50) AD&B Balanced G6.3

|                                                                                   | CODE / KOD<br>BT50                                                                            | D  | D1 | L  | EURO  |
|-----------------------------------------------------------------------------------|-----------------------------------------------------------------------------------------------|----|----|----|-------|
|    | BT50 CM22    | 22 | 40 | 70 | 60.00 |
|    | BT50 CM27    | 27 | 48 | 70 | 61.00 |
|   | BT50 CM32   | 32 | 58 | 70 | 63.00 |
|  | BT50 CM40  | 40 | 70 | 70 | 65.00 |



DIN40 69871 (ISO7388-1) AD&B Balanced G6.3

|                                                                                   | CODE / KOD<br>DIN40 | D  | D1 | L  | EURO  |
|-----------------------------------------------------------------------------------|---------------------|----|----|----|-------|
|  | DIN40 CM16          | 16 | 32 | 55 | 35.00 |
|  | DIN40 CM22          | 22 | 40 | 55 | 35.00 |
|  | DIN40 CM27          | 27 | 48 | 55 | 36.00 |
|  | DIN40 CM32          | 32 | 58 | 60 | 38.00 |
|  | DIN40 CM40          | 40 | 70 | 60 | 41.00 |

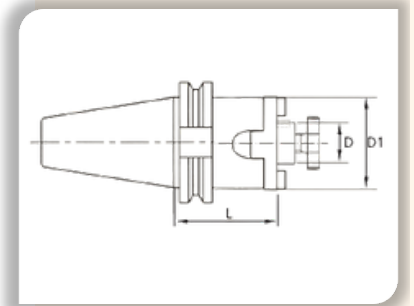





**HSK DIN69893 / ISO 12164 TOOLHOLDERS**  
**HSK DIN69893 / ISO 12164 TAKIM TUTUCULAR**









**HSK ER COLLET CHUCKS G2.5 Balanced**  
**HSK ER Pens Başlıkları G2.5 Balanced**

**HSK50A ER COLLET CHUCKS G2.5 Balanced**

|                                                                                 | CODE / KOD<br>HSK50A | L   | D  | Collet Type and Ø Clamping Range<br>Pens Tipi ve Ø Sıkma Aralığı | EURO  |
|---------------------------------------------------------------------------------|----------------------|-----|----|------------------------------------------------------------------|-------|
|  | HSK50A ER16          | 100 | 28 | ER16 Ø1-12.7mm(1/2")                                             | 60.00 |
|  | HSK50A ER25          | 100 | 42 | ER25 Ø1-20mm                                                     | 60.00 |
|  | HSK50A ER32          | 100 | 50 | ER32 Ø1-25mm                                                     | 60.00 |



**HSK63A ER COLLET CHUCKS G2.5 Balanced**

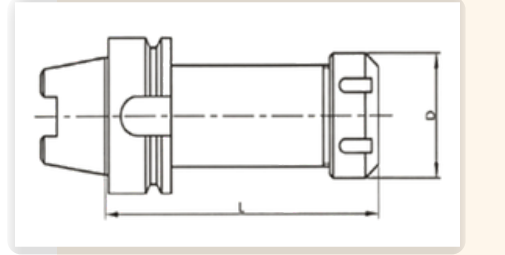

|                                                                                   | CODE / KOD<br>HSK63A       | L   | D  | Collet Type and Ø Clamping Range<br>Pens Tipi ve Ø Sıkma Aralığı | EURO  |
|-----------------------------------------------------------------------------------|----------------------------|-----|----|------------------------------------------------------------------|-------|
|    | HSK63A ER16                | 100 | 28 | ER16 Ø1-12.7mm(1/2")                                             | 60.00 |
|    | HSK63A ER16 160 <b>NEW</b> | 160 | 28 | ER16 Ø1-12.7mm(1/2")                                             | 85.00 |
|    | HSK63A ER25                | 100 | 42 | ER25 Ø1-20mm                                                     | 60.00 |
|    | HSK63A ER25 160 <b>NEW</b> | 160 | 42 | ER25 Ø1-20mm                                                     | 85.00 |
|   | HSK63A ER32                | 100 | 50 | ER35 Ø1-25mm                                                     | 60.00 |
|  | HSK63A ER32 160 <b>NEW</b> | 160 | 50 | ER35 Ø1-25mm                                                     | 85.00 |
|  | HSK63A ER40                | 100 | 63 | ER40 Ø1-32mm                                                     | 63.00 |
|  | HSK63 ER40 160 <b>NEW</b>  | 160 | 63 | ER40 Ø1-32mm                                                     | 89.00 |







**HSK63E ER COLLET CHUCKS G2.5 Balanced**

|                                                                                   | CODE / KOD<br>HSK63E   | L   | D  | Collet Type and Ø Clamping Range<br>Pens Tipi ve Ø Sıkma Aralığı | EURO  |
|-----------------------------------------------------------------------------------|------------------------|-----|----|------------------------------------------------------------------|-------|
|  | HSK63E ER32 <b>NEW</b> | 100 | 50 | ER32 Ø1-25mm                                                     | 60.00 |

**HSK63F ER COLLET CHUCKS G2.5 Balanced**







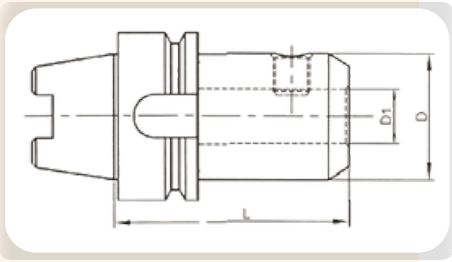

|                                                                                   | CODE / KOD<br>HSK63F   | L  | D  | Collet Type and Ø Clamping Range<br>Pens Tipi ve Ø Sıkma Aralığı | EURO  |
|-----------------------------------------------------------------------------------|------------------------|----|----|------------------------------------------------------------------|-------|
|  | HSK63F ER25 <b>NEW</b> | 70 | 42 | ER25 Ø1-20mm                                                     | 38.00 |
|  | HSK63F ER32 <b>NEW</b> | 75 | 50 | ER32 Ø1-25mm                                                     | 40.00 |
|  | HSK63F ER40 <b>NEW</b> | 75 | 63 | ER40 Ø1-32mm                                                     | 42.00 |

**HSK100A ER COLLET CHUCKS G2.5 Balanced**





|                                                                                   | CODE / KOD<br>HSK100A       | L   | D  | Collet Type and Ø Clamping Range<br>Pens Tipi ve Ø Sıkma Aralığı | EURO  |
|-----------------------------------------------------------------------------------|-----------------------------|-----|----|------------------------------------------------------------------|-------|
|  | HSK100A ER16 100 <b>NEW</b> | 100 | 28 | ER16 Ø1-12.7mm(1/2")                                             | 94.00 |
|  | HSK100A ER25 100 <b>NEW</b> | 100 | 42 | ER25 Ø1-20mm                                                     | 94.00 |
|  | HSK100A ER32 100 <b>NEW</b> | 100 | 50 | ER32 Ø1-25mm                                                     | 90.00 |
|  | HSK100A ER40 100 <b>NEW</b> | 100 | 63 | ER40 Ø1-32mm                                                     | 94.00 |









**HSK63A WELDON CHUCK G2.5 Balanced**  
**HSK63A Weldon Tutucular G2.5**

|                                                                                   | CODE / KOD<br>HSK63A | D1 | D  | L   | EURO  |
|-----------------------------------------------------------------------------------|----------------------|----|----|-----|-------|
|  | HSK63A W06           | 6  | 25 | 65  | 59.00 |
|  | HSK63A W08           | 8  | 28 | 65  | 59.00 |
|  | HSK63A W10           | 10 | 35 | 65  | 59.00 |
|  | HSK63A W12           | 12 | 42 | 80  | 59.00 |
|  | HSK63A W16           | 16 | 48 | 80  | 59.00 |
|  | HSK63A W20           | 20 | 52 | 80  | 59.00 |
|  | HSK63A W25           | 25 | 65 | 110 | 65.00 |
|  | HSK63A W32           | 32 | 72 | 110 | 72.00 |
|  | HSK63A W40           | 40 | 72 | 125 | 90.00 |

**HSK100A WELDON CHUCK G2.5 Balanced**  
**HSK100A Weldon Tutucular G2.5**



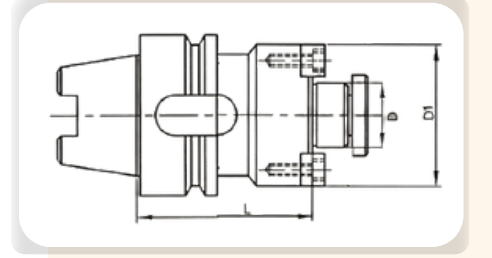

|                                                                                     | CODE / KOD<br>HSK100A | D1 | D  | L   | EURO   |
|-------------------------------------------------------------------------------------|-----------------------|----|----|-----|--------|
|  | HSK100A W16 100L      | 16 | 48 | 100 | 98.00  |
|  | HSK100A W20 100L      | 20 | 52 | 100 | 98.00  |
|  | HSK100A W25 110L      | 25 | 57 | 110 | 105.00 |
|  | HSK100A W32 110L      | 32 | 63 | 110 | 112.00 |
|  | HSK100A W40 120L      | 40 | 72 | 120 | 129.00 |

**HSK63A FACE MILL HOLDERS**  
**HSK63A Alın Sıkmalı Freze Tutucular**



|                                                                                 | CODE / KOD<br>HSK63A                                                     | D1 | D  | L   | EURO  |
|---------------------------------------------------------------------------------|--------------------------------------------------------------------------|----|----|-----|-------|
|  | HSK63A FM16                                                              | 16 | 38 | 50  | 69.00 |
|  | HSK63A FM22                                                              | 22 | 48 | 50  | 69.00 |
|  | HSK63A FM22 100 <span style="color: blue; font-weight: bold;">NEW</span> | 22 | 48 | 100 | 69.00 |
|  | HSK63A FM27                                                              | 27 | 58 | 60  | 70.00 |
|  | HSK63A FM32                                                              | 32 | 78 | 60  | 73.00 |
|  | HSK63A FM40                                                              | 40 | 88 | 60  | 76.00 |



**HSK100A FACE MILL HOLDERS**  
**HSK100A Alın Sıkmalı Freze Tutucular**







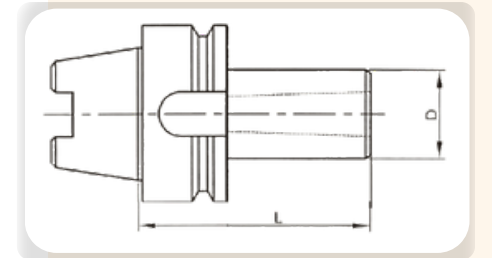

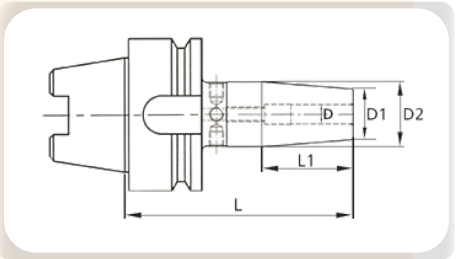
|                                                                                   | CODE / KOD<br>HSK100A                                                 | D1 | D  | L   | EURO   |
|-----------------------------------------------------------------------------------|-----------------------------------------------------------------------|----|----|-----|--------|
|  | HSK100A FM22 <span style="color: blue; font-weight: bold;">NEW</span> | 22 | 48 | 100 | 112.00 |
|  | HSK100A FM27 <span style="color: blue; font-weight: bold;">NEW</span> | 27 | 58 | 100 | 114.00 |
|  | HSK100A FM32 <span style="color: blue; font-weight: bold;">NEW</span> | 32 | 78 | 100 | 119.00 |
|  | HSK100A FM40 <span style="color: blue; font-weight: bold;">NEW</span> | 40 | 88 | 100 | 129.00 |

**HSK MORSE TAPER ADAPTORS**  
**Mors Konik Tutucusu**

|                                                                                   | CODE / KOD<br>HSK63A | D1 | D  | L   | EURO  |
|-----------------------------------------------------------------------------------|----------------------|----|----|-----|-------|
|  | HSK63A MT2           | 2  | 32 | 120 | 67.00 |
|  | HSK63A MT3           | 3  | 40 | 140 | 69.00 |
|  | HSK63A MT4           | 4  | 48 | 160 | 74.00 |





|                                                                                   | CODE / KOD<br>HSK63A | D  | D1 | D2 | L   | L1 | EURO   |
|-----------------------------------------------------------------------------------|----------------------|----|----|----|-----|----|--------|
|  | HSK63A SF04 80       | 4  | 15 | 20 | 80  | -  | 102.00 |
|  | HSK63A SF06 80       | 6  | 21 | 27 | 80  | 36 | 92.00  |
|  | HSK63A SF08 80       | 8  | 21 | 27 | 80  | 36 | 92.00  |
|  | HSK63A SF10 85       | 10 | 24 | 32 | 85  | 42 | 92.00  |
|  | HSK63A SF12 90       | 12 | 24 | 32 | 90  | 47 | 92.00  |
|  | HSK63A SF16 95       | 16 | 27 | 34 | 95  | 50 | 92.00  |
|  | HSK63A SF20 100      | 20 | 33 | 42 | 100 | 52 | 92.00  |
|  | HSK63A SF25 115      | 25 | 44 | 53 | 115 | 58 | 95.00  |

**HSK SHRINK FIT TOOLHOLDERS LONG**  
**HSK Isıtmalı Tutucular Uzun Tip**

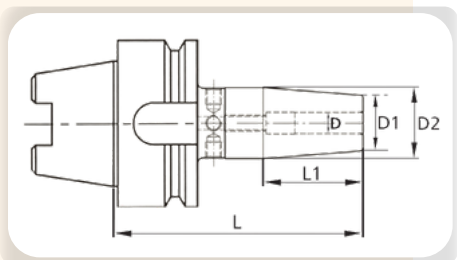

|                                                                                     | CODE / KOD<br>HSK63A | D  | D1 | D2 | L   | L1 | EURO   |
|-------------------------------------------------------------------------------------|----------------------|----|----|----|-----|----|--------|
|  | HSK63A SF04 160      | 4  | 15 | 25 | 160 | -  | 145.00 |
|  | HSK63A SF06 160      | 6  | 21 | 32 | 160 | 36 | 135.00 |
|  | HSK63A SF08 160      | 8  | 21 | 32 | 160 | 36 | 135.00 |
|  | HSK63A SF10 160      | 10 | 24 | 34 | 160 | 42 | 135.00 |
|  | HSK63A SF12 160      | 12 | 24 | 34 | 160 | 47 | 135.00 |

## HSK HYDRAULIC CHUCKS BALANCED G2.5 HSK Hidrolik Tutucular



|  | CODE / KOD<br>HSK63A | D  | D1 | D2 | L   | EURO   |
|--|----------------------|----|----|----|-----|--------|
|  | HSK63A HY06 80       | 6  | 26 | 50 | 80  | 160.00 |
|  | HSK63A HY08 80       | 8  | 28 | 50 | 80  | 160.00 |
|  | HSK63A HY10 85       | 10 | 30 | 50 | 85  | 160.00 |
|  | HSK63A HY12 90       | 12 | 32 | 50 | 90  | 150.00 |
|  | HSK63A HY16 95       | 16 | 38 | 50 | 95  | 160.00 |
|  | HSK63A HY20 100      | 20 | 42 | 50 | 100 | 160.00 |
|  | HSK63A HY25 105      | 25 | 50 | 50 | 105 | 170.00 |
|  | HSK63A HY32 125      | 32 | 60 | -  | 125 | 180.00 |

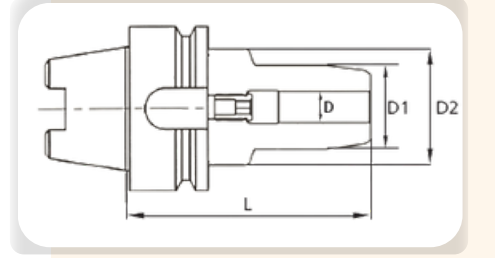

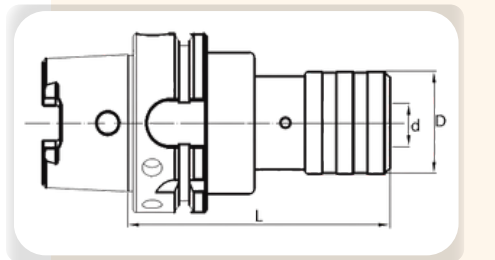

## HSK TAPPING CHUCKS HSK Kılavuz Çekme Başlıkları

|  | CODE / KOD<br>HSK63A | M        | d  | D  | L   | EURO   |
|--|----------------------|----------|----|----|-----|--------|
|  | HSK63A TC1           | M3 - M14 | 19 | 36 | 94  | 145.00 |
|  | HSK63A TC2           | M5 - M24 | 31 | 53 | 135 | 160.00 |







HSK COOLANT TUBE  
HSK Soğutucu Borusu

|                                                                                   | CODE / KOD<br>HSK | SUITABLE HOLDER / UYGUN TUTUCULAR | EURO |
|-----------------------------------------------------------------------------------|-------------------|-----------------------------------|------|
|  | CTHSK63           | HSK63                             | 6.70 |
|  | CTHSK100          | HSK100                            | 9.00 |



HSK SPANNER FOR COOLANT TUBE  
HSK Soğutucu Borusu Anahtarı





|                                                                                     | CODE / KOD<br>HSK | SUITABLE HOLDER / UYGUN TUTUCULAR | EURO  |
|-------------------------------------------------------------------------------------|-------------------|-----------------------------------|-------|
|  | SPHSK63           | HSK63A                            | 14.50 |
|  | SPHSK100          | HSK100A                           | 18.50 |

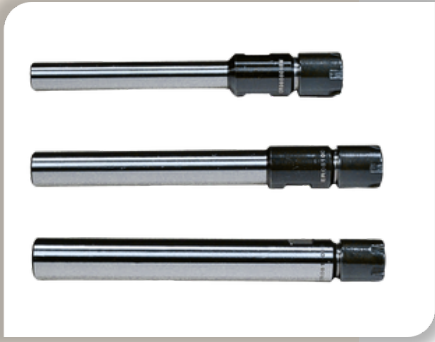

**STRAIGHT SHANK COLLET CHUCKS**  
**Silindirik Saplı Pens Tutucuları**







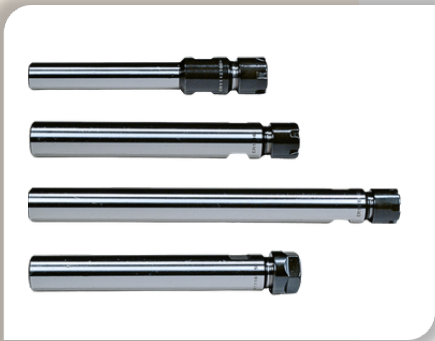

### ER8



|                                                                                   | CODE / KOD<br>ER      | D  | D1 | L   | Collet type and Ø clamping range<br>Pens tipi ve Ø sıkma aralığı | EURO  |
|-----------------------------------------------------------------------------------|-----------------------|----|----|-----|------------------------------------------------------------------|-------|
|  | ER0808085M            | 8  | 12 | 85  | ER8 Ø1-5.5mm                                                     | 25.00 |
|  | ER0810095M            | 10 | 12 | 95  | ER8 Ø1-5.5mm                                                     | 25.00 |
|  | ER0810200M <b>NEW</b> | 10 | 12 | 200 | ER8 Ø1-5.5mm                                                     | 48.00 |
|  | ER0812095M            | 12 | 12 | 95  | ER8 Ø1-5.5mm                                                     | 25.00 |
|  | ER0812140M            | 12 | 12 | 140 | ER8 Ø1-5.5mm                                                     | 35.00 |









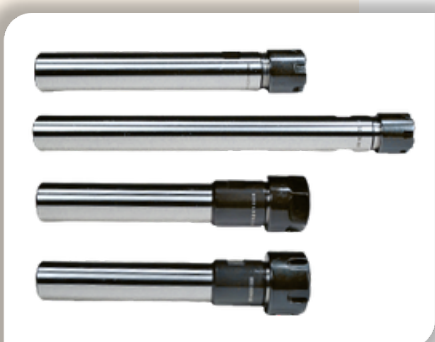



### ER11



|                                                                                     | CODE / KOD<br>ER      | D                   | D1 | L                | Collet type and Ø clamping range<br>Pens tipi ve Ø sıkma aralığı | EURO  |
|-------------------------------------------------------------------------------------|-----------------------|---------------------|----|------------------|------------------------------------------------------------------|-------|
|    | ER1112100M            | 12                  | 16 | 100              | ER11 Ø1-8mm                                                      | 24.00 |
|    | ER1112100H <b>NEW</b> | 12                  | 19 | 100              | ER11 Ø1-8mm                                                      | 24.00 |
|    | ER1116070H <b>NEW</b> | 16                  | 19 | 70               | ER11 Ø1-8mm                                                      | 24.00 |
|   | ER1116085M <b>NEW</b> | 16                  | 16 | 85               | ER11 Ø1-8mm                                                      | 24.00 |
|  | ER1116115M            | 16                  | 16 | 115              | ER11 Ø1-8mm                                                      | 24.00 |
|  | ER1116165M            | 16                  | 16 | 165              | ER11 Ø1-8mm                                                      | 34.00 |
|  | ER1116115H            | 16                  | 19 | 115              | ER11 Ø1-8mm                                                      | 24.00 |
|  | ER1116170H <b>NEW</b> | 16                  | 19 | 170              | ER11 Ø1-8mm                                                      | 46.00 |
|  | ER11127178M           | 12.7<br>(1/2" inch) | 16 | 178<br>(7" inch) | ER11 Ø1-8mm                                                      | 46.00 |







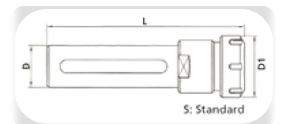
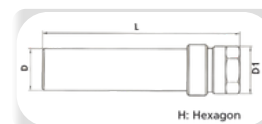
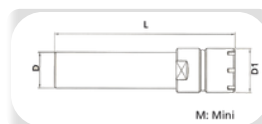





### ER16



|                                                                                     | CODE / KOD<br>ER      | D                    | D1 | L                | Collet type and Ø clamping range<br>Pens tipi ve Ø sıkma aralığı | EURO  |
|-------------------------------------------------------------------------------------|-----------------------|----------------------|----|------------------|------------------------------------------------------------------|-------|
|  | ER1612120M <b>NEW</b> | 12                   | 22 | 120              | ER16 Ø1-12mm                                                     | 28.00 |
|  | ER1616090M            | 16                   | 22 | 90               | ER16 Ø1-12mm                                                     | 24.00 |
|  | ER1616180H <b>NEW</b> | 16                   | 28 | 180              | ER16 Ø1-12mm                                                     | 42.00 |
|  | ER1620080H <b>NEW</b> | 20                   | 28 | 80               | ER16 Ø1-12mm                                                     | 24.00 |
|  | ER1620100M <b>NEW</b> | 20                   | 22 | 100              | ER16 Ø1-12mm                                                     | 24.00 |
|  | ER1620130M            | 20                   | 22 | 130              | ER16 Ø1-12mm                                                     | 24.00 |
|  | ER1620180H <b>NEW</b> | 20                   | 28 | 180              | ER16 Ø1-12mm                                                     | 34.00 |
|  | ER1620200M            | 20                   | 22 | 200              | ER16 Ø1-12mm                                                     | 34.00 |
|  | ER1620130H            | 20                   | 28 | 130              | ER16 Ø1-12mm                                                     | 24.00 |
|  | ER1620130S            | 20                   | 32 | 130              | ER16 Ø1-12mm                                                     | 24.00 |
|  | ER1619178M            | 19.05<br>(3/4" inch) | 22 | 178<br>(7" inch) | ER16 Ø1-12mm                                                     | 42.00 |
|  | ER1622130M            | 22                   | 22 | 130              | ER16 Ø1-12.7mm                                                   | 29.00 |







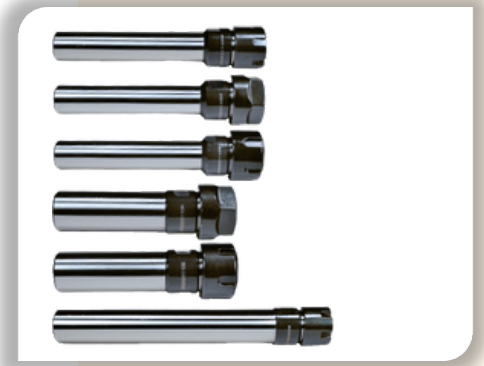



## ER20

|                                                                                 | CODE / KOD<br>ER      | D                 | D1 | L                | Collet type and Ø clamping range<br>Pens tipi ve Ø sıkma aralığı | EURO  |
|---------------------------------------------------------------------------------|-----------------------|-------------------|----|------------------|------------------------------------------------------------------|-------|
|  | ER2020090H <b>NEW</b> | 20                | 34 | 90               | ER20 Ø2-16mm                                                     | 25.00 |
|  | ER2020140M            | 20                | 28 | 140              | ER20 Ø2-16mm                                                     | 25.00 |
|  | ER2020140H            | 20                | 34 | 140              | ER20 Ø2-16mm                                                     | 25.00 |
|  | ER2020140S            | 20                | 35 | 140              | ER20 Ø2-16mm                                                     | 25.00 |
|  | ER2020165H <b>NEW</b> | 20                | 34 | 165              | ER20 Ø2-16mm                                                     | 35.00 |
|  | ER2020200H <b>NEW</b> | 20                | 34 | 200              | ER20 Ø2-16mm                                                     | 42.00 |
|  | ER2022140M            | 22                | 28 | 140              | ER20 Ø2-16mm                                                     | 29.00 |
|  | ER2025110H            | 25                | 34 | 110              | ER20 Ø2-16mm                                                     | 25.00 |
|  | ER2025110S            | 25                | 35 | 110              | ER20 Ø2-16mm                                                     | 25.00 |
|  | ER2025140H <b>NEW</b> | 25                | 34 | 140              | ER20 Ø2-16mm                                                     | 28.00 |
|  | ER2025200M            | 25                | 28 | 200              | ER20 Ø2-16mm                                                     | 35.00 |
|  | ER20254178H           | 25.4<br>(1" inch) | 34 | 178<br>(7" inch) | ER20 Ø2-16mm                                                     | 42.00 |







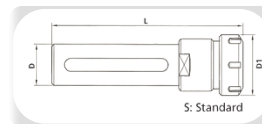
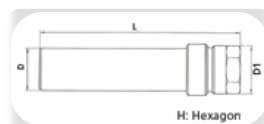
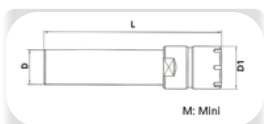
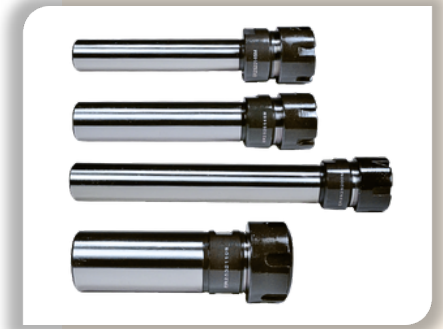



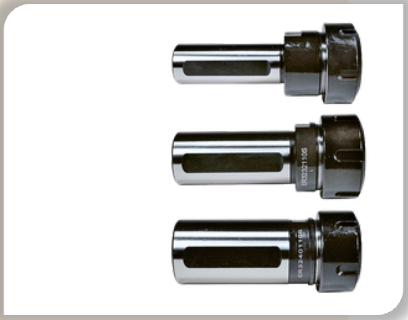

## ER25

|                                                                                   | CODE / KOD<br>ER      | D                 | D1 | L                    | Collet type and Ø clamping range<br>Pens tipi ve Ø sıkma aralığı | EURO  |
|-----------------------------------------------------------------------------------|-----------------------|-------------------|----|----------------------|------------------------------------------------------------------|-------|
|  | ER2520100S <b>NEW</b> | 20                | 42 | 100                  | ER25 Ø1-20mm                                                     | 26.00 |
|  | ER2520145M            | 20                | 35 | 145                  | ER25 Ø1-20mm                                                     | 26.00 |
|  | ER2520145S <b>NEW</b> | 20                | 42 | 145                  | ER25 Ø1-20mm                                                     | 26.00 |
|  | ER2525145M            | 25                | 35 | 145                  | ER25 Ø1-20mm                                                     | 26.00 |
|  | ER2525145S <b>NEW</b> | 25                | 42 | 145                  | ER25 Ø1-20mm                                                     | 26.00 |
|  | ER2525200M            | 25                | 35 | 200                  | ER25 Ø1-20mm                                                     | 36.00 |
|  | ER2532110S            | 32                | 42 | 110                  | ER25 Ø1-20mm                                                     | 26.00 |
|  | ER25254200M           | 25.4<br>(1" inch) | 35 | 200                  | ER25 Ø1-20mm                                                     | 36.00 |
|  | ER25254190M           | 25.4<br>(1" inch) | 35 | 190<br>(7-1/2" inch) | ER25 Ø1-20mm                                                     | 42.00 |









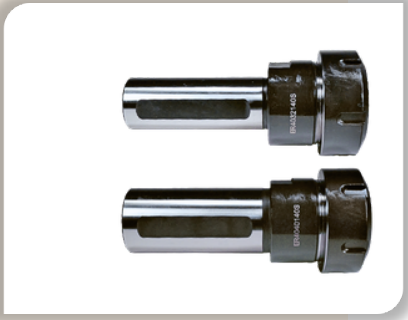

### ER32



|                                                                                   | CODE / KOD<br>ER      | D                      | D1 | L                    | Collet type and Ø clamping range<br>Pens tipi ve Ø sıkma aralığı | EURO  |
|-----------------------------------------------------------------------------------|-----------------------|------------------------|----|----------------------|------------------------------------------------------------------|-------|
|  | ER3220110S <b>NEW</b> | 20                     | 50 | 110                  | ER32 Ø1-25mm                                                     | 28.00 |
|  | ER3225110S            | 25                     | 50 | 110                  | ER32 Ø1-25mm                                                     | 26.00 |
|  | ER3232110S            | 32                     | 50 | 110                  | ER32 Ø1-25mm                                                     | 26.00 |
|  | ER3232150S <b>NEW</b> | 32                     | 50 | 150                  | ER32 Ø1-25mm                                                     | 43.00 |
|  | ER3240110S            | 40                     | 50 | 110                  | ER32 Ø1-25mm                                                     | 28.00 |
|  | ER3219152S            | 19.05<br>(3/4" inch)   | 50 | 152<br>(6" inch)     | ER32 Ø1-25mm                                                     | 53.00 |
|  | ER32254190S           | 25.4<br>(1" inch)      | 50 | 190<br>(7-1/2" inch) | ER32 Ø1-25mm                                                     | 45.00 |
|  | ER32318114S           | 31.75<br>(1-1/4" inch) | 50 | 114<br>(4-7/2" inch) | ER32 Ø1-25mm                                                     | 41.00 |
|  | ER32318152S           | 31.75<br>(1-1/4" inch) | 50 | 152<br>(6" inch)     | ER32 Ø1-25mm                                                     | 43.00 |



### ER40



|                                                                                     | CODE / KOD<br>ER      | D                      | D1 | L                    | Collet type and Ø clamping range<br>Pens tipi ve Ø sıkma aralığı | EURO  |
|-------------------------------------------------------------------------------------|-----------------------|------------------------|----|----------------------|------------------------------------------------------------------|-------|
|  | ER4025110S <b>NEW</b> | 25                     | 63 | 110                  | ER40 Ø1-32mm                                                     | 43.00 |
|  | ER4032140S            | 32                     | 63 | 140                  | ER40 Ø1-32mm                                                     | 35.00 |
|  | ER4040140S            | 40                     | 63 | 140                  | ER40 Ø1-32mm                                                     | 36.00 |
|  | ER40254114S           | 25.4<br>(1" inch)      | 63 | 114<br>(4-1/2" inch) | ER40 Ø1-32mm                                                     | 52.00 |
|  | ER40254178S           | 25.4<br>(1" inch)      | 63 | 178<br>(7" inch)     | ER40 Ø1-32mm                                                     | 64.00 |
|  | ER40318114S           | 31.75<br>(1-1/4" inch) | 63 | 114<br>(4-1/2" inch) | ER40 Ø1-32mm                                                     | 51.00 |
|  | ER40318165S           | 31.75<br>(1-1/4" inch) | 63 | 165<br>(6-1/2" inch) | ER40 Ø1-32mm                                                     | 62.00 |

### ER50



|                                                                                     | CODE / KOD<br>ER      | D  | D1 | L   | Collet type and Ø clamping range<br>Pens tipi ve Ø sıkma aralığı | EURO  |
|-------------------------------------------------------------------------------------|-----------------------|----|----|-----|------------------------------------------------------------------|-------|
|  | ER5040165S <b>NEW</b> | 40 | 78 | 165 | ER50 Ø6-40mm                                                     | 88.00 |
|  | ER5040175S            | 40 | 78 | 175 | ER50 Ø6-40mm                                                     | 88.00 |

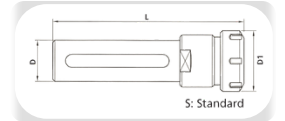
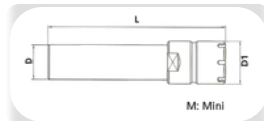





**STRAIGHT SHANK ER COLLET HOLDER SETS  
SİLİNDİRİK SAPLI ER PENS TUTUCU SETLERİ**

SİLİNDİRİK SAPLI ER PENS TUTUCU SETLERİ





|                                                                                   | CODE / KOD<br>ER | Content<br>İçeriği                                                                                                                            | EURO  |
|-----------------------------------------------------------------------------------|------------------|-----------------------------------------------------------------------------------------------------------------------------------------------|-------|
|  | ER1116085MS7     | 7 Ad. ER11 1-7mm CL2<br>(ER11 Ø1-2-3-4-5-6-7)<br>1 Ad. Silindirik Saplı Pens Başlığı ER1116085M<br>1 Ad. SPER11M Mini Anahtar<br>Ahşap Kutuda | 87.00 |
|  | ER1116115MS7     | 7 Ad. ER11 1-7mm CL2<br>(ER11 Ø1-2-3-4-5-6-7)<br>1 Ad. Silindirik Saplı Pens Başlığı ER1116115M<br>1 Ad. SPER11M Mini Anahtar<br>Ahşap Kutuda | 87.00 |





|                                                                                     | CODE / KOD<br>ER | Content<br>İçeriği                                                                                                                                      | EURO  |
|-------------------------------------------------------------------------------------|------------------|---------------------------------------------------------------------------------------------------------------------------------------------------------|-------|
|  | ER1620130HS10    | 10 Ad. ER16 1-10mm CL2<br>(ER16 Ø1-2-3-4-5-6-7-8-9-10)<br>1 Ad. Silindirik Saplı Pens Başlığı ER1620130H<br>1 Ad. ER16 Altıköşe Anahtar<br>Ahşap Kutuda | 87.40 |
|  | ER1620130MS10    | 10 Ad. ER16 1-10mm CL2<br>(ER16 Ø1-2-3-4-5-6-7-8-9-10)<br>1 Ad. Silindirik Saplı Pens Başlığı ER1620130M<br>1 Ad. ER16 Mini Anahtar<br>Ahşap Kutuda     | 89.00 |



|                                                                                     | CODE / KOD<br>ER | Content<br>İçeriği                                                                                                                                             | EURO   |
|-------------------------------------------------------------------------------------|------------------|----------------------------------------------------------------------------------------------------------------------------------------------------------------|--------|
|  | ER2020140HS12    | 12 Ad. ER20 2-13mm CL2<br>(ER20 Ø2-3-4-5-6-7-8-9-10-11-12-13)<br>1 Ad. Silindirik Saplı Pens Başlığı ER2020140H<br>1 Ad. ER20 Altıköşe Anahtar<br>Ahşap Kutuda | 99.90  |
|  | ER2020165HS12    | 12 Ad. ER20 2-13mm CL2<br>(ER20 Ø2-3-4-5-6-7-8-9-10-11-12-13)<br>1 Ad. Silindirik Saplı Pens Başlığı ER2020165H<br>1 Ad. ER20 Altıköşe Anahtar<br>Ahşap Kutuda | 110.00 |
|  | ER2025110HS12    | 12 Ad. ER20 2-13mm CL2<br>(ER20 Ø2-3-4-5-6-7-8-9-10-11-12-13)<br>1 Ad. Silindirik Saplı Pens Başlığı ER2025110H<br>1 Ad. ER20 Altıköşe Anahtar<br>Ahşap Kutuda | 99.90  |

SİLİNDİRİK SAPLI ER PENS TUTUCU SETLERİ

|                                                                                  | CODE / KOD<br>ER | Content<br>İçeriği                                                                                                                                                      | EURO   |
|----------------------------------------------------------------------------------|------------------|-------------------------------------------------------------------------------------------------------------------------------------------------------------------------|--------|
|  | ER2520145SS15    | 15 Ad. ER25 2-16mm CL2<br>(ER25 Ø2-3-4-5-6-7-8-9-10-11-12-13-14-15-16)<br>1 Ad. Silindirik Saplı Pens Başlığı ER2520145S<br>1 Ad. ER25 Standard Anahtar<br>Ahşap Kutuda | 124.00 |
|  | ER2532110S14     | 14 Ad. ER25 3-16mm CL2<br>(ER25 Ø3-4-5-6-7-8-9-10-11-12-13-14-15-16)<br>1 Ad. Silindirik Saplı Pens Başlığı ER2532110S<br>1 Ad. ER25 Standard Anahtar<br>Ahşap Kutuda   | 115.40 |





|                                                                                    | CODE / KOD<br>ER | Content<br>İçeriği                                                                                                                                                                        | EURO   |
|------------------------------------------------------------------------------------|------------------|-------------------------------------------------------------------------------------------------------------------------------------------------------------------------------------------|--------|
|    | ER3232110S14     | 14 Ad. ER32 3-20mm CL2<br>(ER32 Ø3-4-5-6-7-8-9-10-11-12-14-16-18-20)<br>1 Ad. Silindirik Saplı Pens Başlığı ER3232110S<br>1 Ad. ER32 Standard Anahtar<br>Ahşap Kutuda                     | 120.70 |
|  | ER3240110S14     | 14 Ad. ER32 3-20mm CL2<br>(ER32 Ø3-4-5-6-7-8-9-10-11-12-14-16-18-20)<br>1 Ad. Silindirik Saplı Pens Başlığı ER3240110S<br>1 Ad. ER32 Standard Anahtar<br>Ahşap Kutuda                     | 122.70 |
|  | ER3232110S18     | 18 Ad. ER32 3-20mm CL2<br>(ER32 Ø3-4-5-6-7-8-9-10-11-12-13-14-15-16-17-18-19-20)<br>1 Ad. Silindirik Saplı Pens Başlığı ER3232110S<br>1 Ad. ER32 Standard Anahtar<br>Ahşap Kutuda         | 139.10 |
|  | ER3232150SS18    | 18 Ad. ER32 3-20mm CL2<br>(ER32 Ø3-4-5-6-7-8-9-10-11-12-13-14-15-16-17-18-19-20)<br>1 Ad. Silindirik Saplı Pens Başlığı ER3232150S<br>1 Ad. ER32 Standard Anahtar<br>Ahşap Kutuda         | 157.00 |
|  | ER3240110S18     | 18 Ad. ER32 3-20mm CL2<br>(ER32 Ø3-4-5-6-7-8-9-10-11-12-13-14-15-16-17-18-19-20)<br>1 Ad. Silindirik Saplı Pens Başlığı ER3240110S<br>1 Ad. ER32 Standard Anahtar<br>Ahşap Kutuda         | 141.10 |
|  | ER3232110S21     | 21 Ad. ER32 2-25mm CL2<br>(ER32 Ø2-3-4-5-6-7-8-9-10-11-12-13-14-15-16-17-18-19-20-22-25)<br>1 Ad. Silindirik Saplı Pens Başlığı ER3232110S<br>1 Ad. ER32 Standard Anahtar<br>Ahşap Kutuda | 175.00 |
|  | ER3240110S21     | 21 Ad. ER32 2-25mm CL2<br>(ER32 Ø2-3-4-5-6-7-8-9-10-11-12-13-14-15-16-17-18-19-20-22-25)<br>1 Ad. Silindirik Saplı Pens Başlığı ER3240110S<br>1 Ad. ER32 Standard Anahtar<br>Ahşap Kutuda | 177.00 |



## SİLİNDİRİK SAPLI ER PENS TUTUCU SETLERİ









|                                                                                   | CODE / KOD<br>ER | Content<br>İçeriği                                                                                                                                                                                  | EURO   |
|-----------------------------------------------------------------------------------|------------------|-----------------------------------------------------------------------------------------------------------------------------------------------------------------------------------------------------|--------|
|  | ER4032140S23     | 23 Ad. ER40 4-26mm CL2<br>(ER40 Ø4-5-6-7-8-9-10-11-12-13-14-15-16-17-18-<br>19-20-21-22-23-24-25-26)<br>1 Ad. Silindirik Saplı Pens Başlığı ER4032140S<br>1 Ad. ER40 C Tipi Anahtar<br>Ahşap Kutuda | 203.00 |
|  | ER4040140S23     | 23 Ad. ER40 4-26mm CL2<br>(ER40 Ø4-5-6-7-8-9-10-11-12-13-14-15-16-17-18-<br>19-20-21-22-23-24-25-26)<br>1 Ad. Silindirik Saplı Pens Başlığı ER4040140S<br>1 Ad. ER40 C Tipi Anahtar<br>Ahşap Kutuda | 204.00 |





**ER&OZ COLLET SETS WITH CHUCKS  
BAŞLIKLİ ER ve OZ PENS TAKIMLARI**













|                                                                                   | CODE / KOD   | Content İçeriği                                                                                                                  | EURO   |
|-----------------------------------------------------------------------------------|--------------|----------------------------------------------------------------------------------------------------------------------------------|--------|
|  | BT30ER16S10  | 10 Ad. ER16 1-10mm CL2<br>(ER16 Ø1-2-3-4-5-6-7-8-9-10)<br>1 Ad. ER16 Pens Başlığı<br>1 Ad. ER16 Altıköşe Anahtar<br>Aşşap Kutuda | 92.40  |
|  | BT40ER16S10  |                                                                                                                                  | 91.40  |
|  | DIN30ER16S10 |                                                                                                                                  | 92.40  |
|  | DIN40ER16S10 |                                                                                                                                  | 91.40  |
|  | ISO30ER16S10 |                                                                                                                                  | 92.40  |
|  | ISO40ER16S10 |                                                                                                                                  | 91.40  |
|  | HSK63ER16S10 |                                                                                                                                  | 123.40 |













|                                                                                     | CODE / KOD   | Content İçeriği                                                                                                                        | EURO   |
|-------------------------------------------------------------------------------------|--------------|----------------------------------------------------------------------------------------------------------------------------------------|--------|
|    | BT40ER20S12  | 12 Ad. ER20 2-13mm Class 2<br>(Ø2-3-4-5-6-7-8-9-10-11-12-13)<br>1 Ad. ER20 Pens Başlığı<br>1 Ad. ER20 Altıköşe Anahtar<br>Aşşap Kutuda | 102.90 |
|   | DIN40ER20S12 |                                                                                                                                        | 102.90 |
|  | MT2ER20S12   |                                                                                                                                        | 101.90 |











|                                                                                     | CODE / KOD   | Content İçeriği                                                                                                                             | EURO   |
|-------------------------------------------------------------------------------------|--------------|---------------------------------------------------------------------------------------------------------------------------------------------|--------|
|  | BT30ER32S14  | 14 Ad. ER32 3-20mm Class 2<br>(Ø3-4-5-6-7-8-9-10-11-12-14-16-18-20)<br>1 Ad. ER32 Pens Başlığı<br>1 Ad. ER32 C Tipi Anahtar<br>Aşşap Kutuda | 123.70 |
|  | BT40ER32S14  |                                                                                                                                             | 122.70 |
|  | DIN30ER32S14 |                                                                                                                                             | 123.70 |
|  | DIN40ER32S14 |                                                                                                                                             | 122.70 |
|  | ISO30ER32S14 |                                                                                                                                             | 123.70 |
|  | ISO40ER32S14 |                                                                                                                                             | 122.70 |
|  | MT2ER32S14   |                                                                                                                                             | 122.70 |
|  | MT3ER32S14   |                                                                                                                                             | 123.70 |
|  | MT4ER32S14   |                                                                                                                                             | 124.70 |
|  | HSK63ER32S14 |                                                                                                                                             | 154.70 |







## ER COLLET SET WITH CHUCKS BAŞLIKLİ ER PENS TAKIMLARI

|                                                                                  | CODE / KOD   | Content İçeriği                                                                                                                                         | EURO   |
|----------------------------------------------------------------------------------|--------------|---------------------------------------------------------------------------------------------------------------------------------------------------------|--------|
|  | BT30ER32S18  | 18 Ad. ER32 3-20mm Class 2<br>(Ø3-4-5-6-7-8-9-10-11-12-13-14-15-16-17-18-19-20)<br>1 Ad. ER32 Pens Başlığı<br>1 Ad. ER32 C Tipi Anahtar<br>Ahşap Kutuda | 142.10 |
|  | BT40ER32S18  |                                                                                                                                                         | 141.10 |
|  | DIN30ER32S18 |                                                                                                                                                         | 142.10 |
|  | DIN40ER32S18 |                                                                                                                                                         | 141.10 |
|  | ISO30ER32S18 |                                                                                                                                                         | 142.10 |
|  | ISO40ER32S18 |                                                                                                                                                         | 141.10 |
|  | MT2ER32S18   |                                                                                                                                                         | 141.10 |
|  | MT3ER32S18   |                                                                                                                                                         | 142.10 |
|  | MT4ER32S18   |                                                                                                                                                         | 143.10 |
|  | HSK63ER32S18 |                                                                                                                                                         | 173.10 |



|                                                                                    | CODE / KOD   | Content İçeriği                                                                                                                                                 | EURO   |
|------------------------------------------------------------------------------------|--------------|-----------------------------------------------------------------------------------------------------------------------------------------------------------------|--------|
|  | BT30ER32S21  | 21 Ad. ER32 2-25mm Class 2<br>(Ø2-3-4-5-6-7-8-9-10-11-12-13-14-15-16-17-18-19-20-22-25)<br>1 Ad. ER32 Pens Başlığı<br>1 Ad. ER32 C Tipi Anahtar<br>Ahşap Kutuda | 178.00 |
|  | BT40ER32S21  |                                                                                                                                                                 | 177.00 |
|  | DIN30ER32S21 |                                                                                                                                                                 | 178.00 |
|  | DIN40ER32S21 |                                                                                                                                                                 | 177.00 |
|  | ISO30ER32S21 |                                                                                                                                                                 | 178.00 |
|  | ISO40ER32S21 |                                                                                                                                                                 | 177.00 |
|  | MT2ER32S21   |                                                                                                                                                                 | 177.00 |
|  | MT3ER32S21   |                                                                                                                                                                 | 178.00 |
|  | MT4ER32S21   |                                                                                                                                                                 | 179.00 |
|  | HSK63ER32S21 |                                                                                                                                                                 | 209.00 |



|                                                                                    | CODE / KOD   | Content İçeriği                                                                                                                                                         | EURO   |
|------------------------------------------------------------------------------------|--------------|-------------------------------------------------------------------------------------------------------------------------------------------------------------------------|--------|
|  | BT40ER40S23  | 23 Ad. ER40 4-26mm Class 2<br>(Ø4-5-6-7-8-9-10-11-12-13-14-15-16-17-18-19-20-21-22-23-24-25-26)<br>1 Ad. ER40 Pens Başlığı<br>1 Ad. ER40 C Tipi Anahtar<br>Ahşap Kutuda | 198.00 |
|  | DIN40ER40S23 |                                                                                                                                                                         | 198.00 |
|  | ISO40ER40S23 |                                                                                                                                                                         | 198.00 |
|  | MT3ER40S23   |                                                                                                                                                                         | 198.00 |
|  | MT4ER40S23   |                                                                                                                                                                         | 199.00 |
|  | HSK63ER40S23 |                                                                                                                                                                         | 231.00 |





|                                                                                   | CODE / KOD     | Content İçeriği                                      | EURO   |
|-----------------------------------------------------------------------------------|----------------|------------------------------------------------------|--------|
|  | BT40OZ25ASET7  | 7 Ad. OZ25 2-25mm Class 2<br>( Ø6-8-10-12-16-20-25 ) | 135.30 |
|  | DIN40OZ25ASET7 | 1 Ad. OZ25 Pens Başlığı                              | 135.30 |
|  | ISO40OZ25ASET7 | 1 Ad. OZ Tipi Anahtar<br>Plastik Kutuda              | 135.30 |









|                                                                                    | CODE / KOD   | Content İçeriği                                      | EURO   |
|------------------------------------------------------------------------------------|--------------|------------------------------------------------------|--------|
|   | MT2OZ25ASET7 | 7 Ad. OZ25 2-25mm Class 2<br>( Ø6-8-10-12-16-20-25 ) | 133.30 |
|   | MT3OZ25ASET7 | 1 Ad. MK...OZ25 Pens Başlığı                         | 133.30 |
|  | MT4OZ25ASET7 | 1 Ad. OZ Tipi Anahtar<br>Plastik Kutuda              | 135.30 |



**DOUBLE CONTACT TOOLHOLDERS**  
**ÇİFT TEMAS YÜZEYLİ ISITMALI TUTUCU**



JIS B 6339 (MAS403 BT) AD&B G2.5 Balanced



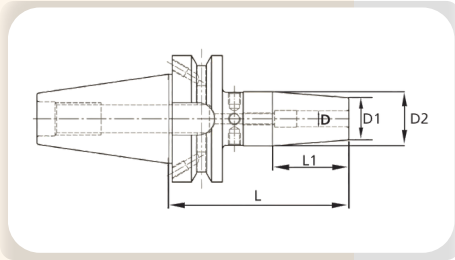



|                                                                                   | CODE / KOD<br>BTC40 | D  | D1 | D2 | L   | L1 | EURO   |
|-----------------------------------------------------------------------------------|---------------------|----|----|----|-----|----|--------|
|  | BTC40 SF06 90       | 6  | 21 | 27 | 90  | 36 | 100.00 |
|  | BTC40 SF08 90       | 8  | 21 | 27 | 90  | 36 | 100.00 |
|  | BTC40 SF10 90       | 10 | 24 | 32 | 90  | 42 | 100.00 |
|  | BTC40 SF12 90       | 12 | 24 | 32 | 90  | 47 | 100.00 |
|  | BTC40 SF16 90       | 16 | 27 | 34 | 90  | 50 | 100.00 |
|  | BTC40 SF20 90       | 20 | 33 | 42 | 90  | 52 | 100.00 |
|  | BTC40 SF25 100      | 25 | 44 | 53 | 100 | 58 | 104.00 |









**TOOLHOLDER MACHINEABLE BLANKS**  
**İşlenebilir Taslak Takım Tutucular HamBlok**

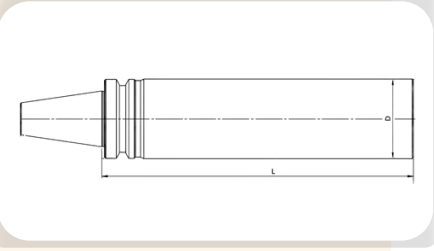



**BT JIS B 6339 (MAS403) TOOLHOLDER MACHINEABLE BLANKS**  
**BT JIS B 6339 (MAS403) İşlenebilir Taslak Takım Tutucular (Hamblok)**

|                                                                                   | CODE / KOD<br>BT                                                                              | L   | D  | EURO   |
|-----------------------------------------------------------------------------------|-----------------------------------------------------------------------------------------------|-----|----|--------|
|  | BT30 50 160  | 160 | 50 | 80.00  |
|  | BT40 63 250  | 250 | 63 | 80.00  |
|  | BT50 97 320  | 320 | 97 | 150.00 |

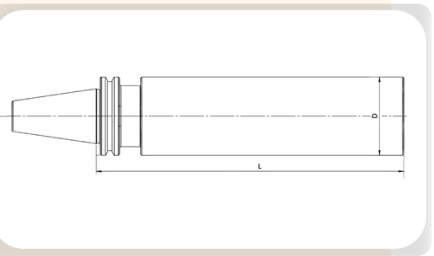

**DIN 69871 (ISO7388-1) TOOLHOLDER MACHINEABLE BLANKS**  
**DIN 69871 (ISO7388-1) İşlenebilir Taslak Takım Tutucular (Hamblok)**

|                                                                                     | CODE / KOD<br>DIN                                                                                | L   | D  | EURO   |
|-------------------------------------------------------------------------------------|--------------------------------------------------------------------------------------------------|-----|----|--------|
|  | DIN40 63 250  | 250 | 63 | 80.00  |
|  | DIN50 97 320  | 320 | 97 | 150.00 |

**ISO (DIN2080) TOOLHOLDER MACHINEABLE BLANKS**  
**ISO (DIN2080) İşlenebilir Taslak Takım Tutucular (Hamblok)**

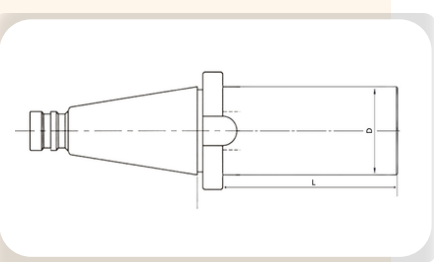
|                                                                                     | CODE / KOD<br>ISO                                                                                | L   | D  | EURO   |
|-------------------------------------------------------------------------------------|--------------------------------------------------------------------------------------------------|-----|----|--------|
|  | ISO40 63 250  | 250 | 63 | 80.00  |
|  | ISO50 97 320  | 320 | 97 | 150.00 |



**HSK TOOLHOLDER MACHINEABLE BLANKS**  
**HSK İşlenebilir Taslak Takım Tutucular (Ham blok)**

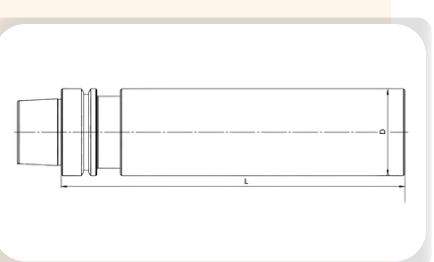



|                                                                                     | CODE / KOD<br>HSK                                                                                 | L   | D  | EURO   |
|-------------------------------------------------------------------------------------|---------------------------------------------------------------------------------------------------|-----|----|--------|
|  | HSK63A 63 250  | 250 | 63 | 110.00 |

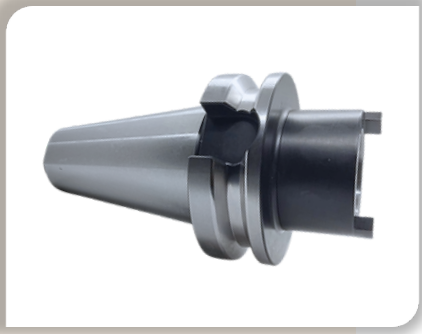











**TAPERS REDUCTION ADAPTORS**  
**Konik Redüksiyon Adaptörleri**

**TAPERS REDUCTION ADAPTORS**  
**Konik Redüksiyon Adaptörü**

|                                                                                   | CODE / KOD<br>BT                                                                             | Outside Taper / Inside Taper<br>Dış Konik / İç Konikler | EURO   |
|-----------------------------------------------------------------------------------|----------------------------------------------------------------------------------------------|---------------------------------------------------------|--------|
|  | RTPRBT5040  | BT50 / BT40 DIN40 ISO40                                 | 110.00 |
|  | RTPRBT4030  | BT40 / BT30 DIN30 ISO30                                 | 80.00  |

|                                                                                   | CODE / KOD<br>DIN                                                                             | Outside Taper / Inside Taper<br>Dış Konik / İç Konikler | EURO   |
|-----------------------------------------------------------------------------------|-----------------------------------------------------------------------------------------------|---------------------------------------------------------|--------|
|  | RTPRDIN5040  | DIN69871 (ISO) 50 / BT40 DIN40 ISO40                    | 110.00 |
|  | RTPRDIN4030  | DIN69871 (ISO) 40 / BT30 DIN40 ISO30                    | 80.00  |







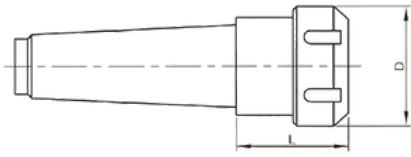

|                                                                                     | CODE / KOD<br>ISO                                                                               | Outside Taper / Inside Taper<br>Dış Konik / İç Konikler | EURO   |
|-------------------------------------------------------------------------------------|-------------------------------------------------------------------------------------------------|---------------------------------------------------------|--------|
|  | RTPRISO5040  | DIN2080 (ISO) 50 / BT40 DIN40 ISO40                     | 110.00 |
|  | RTPRISO4030  | DIN2080 (ISO) 40 / BT30 DIN30 ISO30                     | 80.00  |



**DIN 228 MORSE TAPER TOOLHOLDERS**  
**DIN 228 Mors Konik Takım Tutucuları**







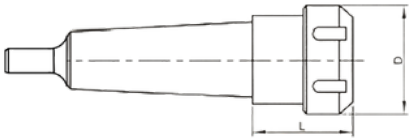

**DIN228 A ER COLLET CHUCKS / ER Pens Başlıkları**



|                                                                                   | CODE / KOD<br>MT    | L  | D  | Collet Type and Ø Clamping Range<br>pens tipi ve Ø sıkma aralığı | EURO  |
|-----------------------------------------------------------------------------------|---------------------|----|----|------------------------------------------------------------------|-------|
|  | MT2 ER20            | 50 | 32 | ER20 Ø1-20mm                                                     | 27.00 |
|  | MT2 ER25            | 55 | 42 | ER25 Ø1-20mm                                                     | 27.00 |
|  | MT2 ER32            | 70 | 50 | ER32 Ø1-25mm                                                     | 28.00 |
|  | MT3 ER25            | 55 | 42 | ER25 Ø1-20mm                                                     | 28.00 |
|  | MT3 ER32            | 70 | 50 | ER32 Ø1-25mm                                                     | 29.00 |
|  | MT3 ER40            | 75 | 63 | ER40 Ø 1-32mm                                                    | 30.00 |
|  | MT4 ER32            | 70 | 50 | ER32 Ø1-25mm                                                     | 30.00 |
|  | MT4 ER40            | 75 | 63 | ER40 Ø 1-32mm                                                    | 31.00 |
|  | MT5 ER40 <b>NEW</b> | 53 | 63 | ER40 Ø 1-32mm                                                    | 64.00 |





**DIN228 B ER COLLET CHUCKS (With Tang Type)**  
ER Pens Başlıkları (Çakma Morslu Tip)



|                                                                                     | CODE / KOD<br>MT     | L  | D  | Collet Type and Ø Clamping Range<br>pens tipi ve Ø sıkma aralığı | EURO  |
|-------------------------------------------------------------------------------------|----------------------|----|----|------------------------------------------------------------------|-------|
|  | MTB1 ER16 <b>NEW</b> | 54 | 28 | ER32 Ø 1-25mm                                                    | 29.00 |
|  | MTB2 ER25 <b>NEW</b> | 58 | 43 | ER25 Ø 1-20mm                                                    | 30.00 |
|  | MTB2 ER32 <b>NEW</b> | 62 | 50 | ER32 Ø 1-25mm                                                    | 29.00 |
|  | MTB3 ER32 <b>NEW</b> | 65 | 50 | ER32 Ø 1-25mm                                                    | 31.00 |
|  | MTB3 ER40 <b>NEW</b> | 70 | 63 | ER40 Ø 1-32mm                                                    | 32.00 |
|  | MTB4 ER32 <b>NEW</b> | 64 | 50 | ER32 Ø 1-25mm                                                    | 32.00 |
|  | MTB4 ER40 <b>NEW</b> | 77 | 63 | ER40 Ø 1-32mm                                                    | 33.00 |
|  | MTB5 ER40 <b>NEW</b> | 82 | 63 | ER40 Ø 1-32mm                                                    | 68.00 |



**DIN228 A OZ25 DIN6388 COLLET CHUCKS / Pens Başlıkları**

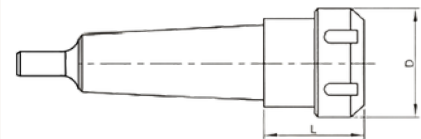

|                                                                                     | CODE / KOD<br>MT    | L  | D  | Collet Type and Ø Clamping Range<br>pens tipi ve Ø sıkma aralığı | EURO  |
|-------------------------------------------------------------------------------------|---------------------|----|----|------------------------------------------------------------------|-------|
|  | MT2 OZ25            | 88 | 60 | OZ25 Ø2-30mm                                                     | 40.00 |
|  | MT3 OZ25            | 64 | 60 | OZ25 Ø2-30mm                                                     | 40.00 |
|  | MT4 OZ25            | 68 | 60 | OZ25 Ø2-30mm                                                     | 42.00 |
|  | MT5 OZ32 <b>NEW</b> | 76 | 72 | OZ32 Ø4-32mm                                                     | 90.00 |

**DIN228 B OZ25 DIN6388 COLLET CHUCKS (With Tang Type)**  
DIN228 B OZ25 DIN6388 Pens Başlıkları (Çakma Morslu Tip)



|                                                                                     | CODE / KOD<br>MT     | L  | D  | Collet Type and Ø Clamping Range<br>pens tipi ve Ø sıkma aralığı | EURO  |
|-------------------------------------------------------------------------------------|----------------------|----|----|------------------------------------------------------------------|-------|
|  | MTB2 OZ25 <b>NEW</b> | 80 | 60 | OZ25 Ø2-30mm                                                     | 40.00 |
|  | MTB3 OZ25 <b>NEW</b> | 67 | 60 | OZ25 Ø2-30mm                                                     | 40.00 |
|  | MTB4 OZ25 <b>NEW</b> | 68 | 60 | OZ25 Ø2-30mm                                                     | 42.00 |

**DIN228 A MORSE TAPER SHANK FACE MILL ADAPTORS**  
Mors Konik Saplı Alından Sıkmalı Freze Tutucular

**DIN228 A MORSE TAPER / Mors Konik**

|  | CODE / KOD<br>MT | D  | D1 | L   | L1 | EURO  |
|--|------------------|----|----|-----|----|-------|
|  | MT2 FM16         | 16 | 32 | 124 | 42 | 29.00 |
|  | MT2 FM22         | 22 | 40 | 126 | 44 | 29.00 |
|  | MT2 FM27         | 27 | 48 | 128 | 46 | 30.00 |
|  | MT2 FM32         | 32 | 58 | 128 | 46 | 31.00 |
|  | MT2 FM40         | 40 | 66 | 128 | 46 | 32.00 |
|  | MT3 FM16         | 16 | 32 | 146 | 42 | 30.00 |
|  | MT3 FM22         | 22 | 40 | 148 | 44 | 30.00 |
|  | MT3 FM27         | 27 | 48 | 150 | 46 | 31.00 |
|  | MT3 FM32         | 32 | 58 | 153 | 49 | 32.00 |
|  | MT3 FM40         | 40 | 66 | 153 | 53 | 33.00 |
|  | MT4 FM16         | 16 | 32 | 174 | 42 | 31.00 |
|  | MT4 FM22         | 22 | 40 | 176 | 44 | 31.00 |
|  | MT4 FM27         | 27 | 48 | 178 | 46 | 32.00 |
|  | MT4 FM32         | 32 | 58 | 181 | 49 | 33.00 |
|  | MT4 FM40         | 40 | 70 | 185 | 53 | 34.00 |

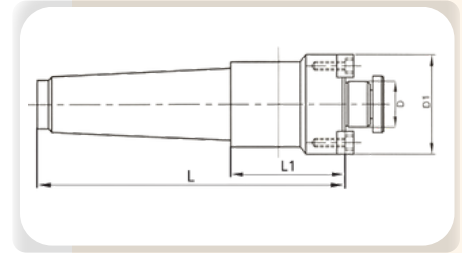

**COMBI SHELL MILL ADAPTORS (with drive ring and key)**  
Kombine Freze Tutucular (İstavroz pul ve kamalı)

**DIN228 A MORSE TAPER / Mors Konik**

|  | CODE / KOD<br>MT | D  | D1 | L   | L1 | EURO  |
|--|------------------|----|----|-----|----|-------|
|  | MT2 CM16         | 16 | 32 | 124 | 44 | 32.00 |
|  | MT2 CM22         | 22 | 40 | 126 | 50 | 32.00 |
|  | MT2 CM27         | 27 | 48 | 128 | 54 | 33.00 |
|  | MT2 CM32         | 32 | 58 | 128 | 57 | 34.00 |
|  | MT2 CM40         | 40 | 70 | 128 | 60 | 35.00 |
|  | MT3 CM16         | 16 | 32 | 146 | 44 | 33.00 |
|  | MT3 CM22         | 22 | 40 | 148 | 50 | 33.00 |
|  | MT3 CM27         | 27 | 48 | 150 | 54 | 34.00 |
|  | MT3 CM32         | 32 | 58 | 153 | 62 | 35.00 |
|  | MT3 CM40         | 40 | 68 | 153 | 62 | 36.00 |
|  | MT4 CM16         | 16 | 32 | 172 | 44 | 34.00 |
|  | MT4 CM22         | 22 | 40 | 175 | 50 | 34.00 |
|  | MT4 CM27         | 27 | 48 | 178 | 54 | 35.00 |
|  | MT4 CM32         | 32 | 58 | 196 | 62 | 36.00 |
|  | MT4 CM40         | 40 | 70 | 196 | 62 | 38.00 |

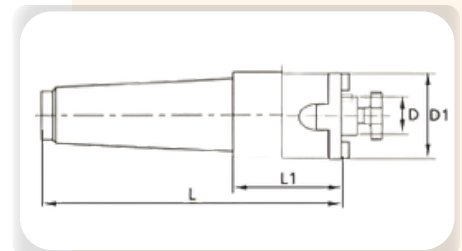

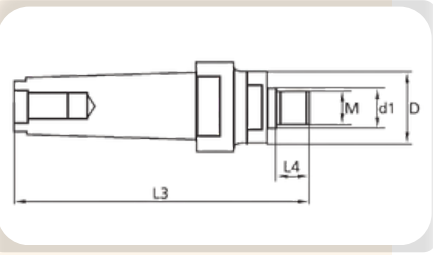







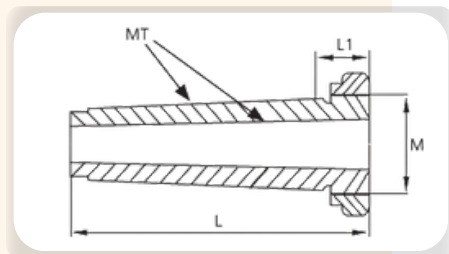

### DIN228 A MORSE TAPER / Mors Konik

|                                                                                   | CODE / KOD<br>MT | L3  | L4 | D  | d1 | EURO  |
|-----------------------------------------------------------------------------------|------------------|-----|----|----|----|-------|
|  | MT3 M12          | 151 | 17 | 22 | 14 | 24.00 |
|  | MT3 M16          | 154 | 19 | 32 | 18 | 24.00 |
|  | MT3 M20          | 157 | 22 | 40 | 22 | 25.00 |
|  | MT3 M24          | 159 | 24 | 48 | 26 | 26.00 |
|  | MT4 M12          | 179 | 17 | 22 | 14 | 26.00 |
|  | MT4 M16          | 182 | 19 | 32 | 18 | 27.00 |
|  | MT4 M20          | 185 | 22 | 40 | 22 | 28.00 |

### REDUCTION WITH EXTRACTING NUT Çıkarma Somunlu Redüksiyon Kovanlar



### DIN228 A MORSE TAPER / Mors Konik

|                                                                                     | CODE / KOD<br>MT | L   | L1 | M       | EURO  |
|-------------------------------------------------------------------------------------|------------------|-----|----|---------|-------|
|  | MT2 MT1 XN       | 85  | 18 | M22X1.5 | 27.00 |
|  | MT3 MT1 XN       | 101 | 20 | M27X1.5 | 27.00 |
|  | MT3 MT2 XN       | 101 | 20 | M27X1.5 | 25.00 |
|  | MT4 MT1 XN       | 127 | 24 | M34X2.0 | 27.00 |
|  | MT4 MT2 XN       | 127 | 24 | M34X2.0 | 25.00 |
|  | MT4 MT3 XN       | 127 | 24 | M34X2.0 | 25.00 |
|  | MT5 MT3 XN       | 157 | 27 | M48X2.0 | 27.00 |
|  | MT5 MT4 XN       | 157 | 27 | M48X2.0 | 27.00 |

**MORSE TAPER DRILL CHUCK ARBOR : MT DIN 228 B - DIN 238 B (with Tang)**  
Mors Konik Matkap Mandren Adaptörü (Çakma Morslu Tip)

|  | CODE / KOD<br>MT | Shank<br>Taper<br>Sap Koniği<br>MT | Front<br>Taper<br>Uç Koniği<br>B | L   | L1  | L2 | D      | D1     | EURO  |
|--|------------------|------------------------------------|----------------------------------|-----|-----|----|--------|--------|-------|
|  | MT1 B10          | MT1                                | B10                              | 86  | 65  | 21 | 12.065 | 10.094 | 4.60  |
|  | MT1 B12          | MT1                                | B12                              | 90  | 65  | 25 | 12.065 | 12.065 | 4.60  |
|  | MT2 B10          | MT2                                | B10                              | 101 | 80  | 21 | 17.780 | 10.094 | 5.30  |
|  | MT2 B12          | MT2                                | B12                              | 105 | 80  | 25 | 17.780 | 12.065 | 5.30  |
|  | MT2 B16          | MT2                                | B16                              | 112 | 80  | 32 | 17.780 | 15.733 | 5.30  |
|  | MT2 B18          | MT2                                | B18                              | 120 | 80  | 40 | 17.780 | 17.780 | 5.30  |
|  | MT3 B12          | MT3                                | B12                              | 124 | 99  | 25 | 23.825 | 12.065 | 6.00  |
|  | MT3 B16          | MT3                                | B16                              | 131 | 99  | 32 | 23.825 | 15.733 | 6.00  |
|  | MT3 B18          | MT3                                | B18                              | 139 | 99  | 40 | 23.825 | 17.780 | 6.10  |
|  | MT3 B22          | MT3                                | B22                              | 147 | 99  | 48 | 23.825 | 21.793 | 6.20  |
|  | MT4 B16          | MT4                                | B16                              | 156 | 124 | 32 | 31.267 | 15.733 | 7.20  |
|  | MT4 B18          | MT4                                | B18                              | 164 | 124 | 40 | 31.267 | 17.780 | 7.30  |
|  | MT4 B22          | MT4                                | B22                              | 172 | 124 | 48 | 31.267 | 21.793 | 7.40  |
|  | MT5 B16          | MT5                                | B16                              | 188 | 156 | 32 | 44.399 | 17.733 | 16.00 |
|  | MT5 B18          | MT5                                | B18                              | 196 | 156 | 40 | 44.399 | 17.780 | 16.00 |
|  | MT5 B22          | MT5                                | B22                              | 204 | 156 | 48 | 44.399 | 21.793 | 16.50 |
|  | MT5 B24          | MT5                                | B24                              | 214 | 156 | 58 | 44.399 | 23.825 | 17.00 |

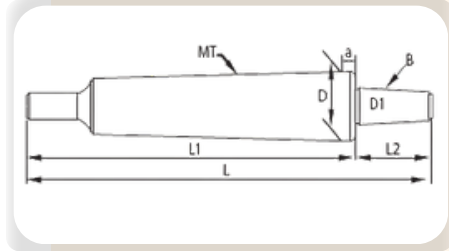





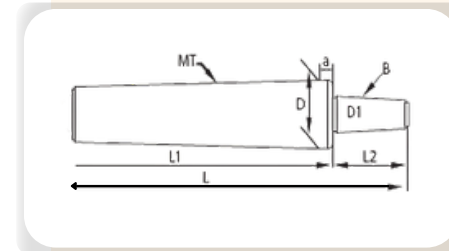

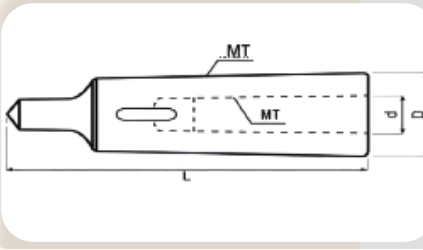







**MORSE TAPER DRILL CHUCK ARBOR : MT DIN 228 A - DIN 238 A**  
MORS KONİK MATKAP MANDREN ADAPTÖRÜ

|  | CODE / KOD<br>MTA           | L   | L1  | L2 | D      | D1     | EURO  |
|--|-----------------------------|-----|-----|----|--------|--------|-------|
|  | MTA1 B10 <small>NEW</small> | 79  | 58  | 21 | 12.065 | 10.094 | 6.30  |
|  | MTA1 B12 <small>NEW</small> | 83  | 58  | 25 | 12.065 | 12.065 | 6.30  |
|  | MTA1 B16 <small>NEW</small> | 90  | 61  | 30 | 12.065 | 15.733 | 6.30  |
|  | MTA2 B10 <small>NEW</small> | 90  | 70  | 21 | 17.780 | 12.065 | 7.00  |
|  | MTA2 B12 <small>NEW</small> | 95  | 80  | 25 | 17.780 | 12.065 | 7.00  |
|  | MTA2 B16 <small>NEW</small> | 102 | 70  | 32 | 17.780 | 15.733 | 7.00  |
|  | MTA3 B12 <small>NEW</small> | 111 | 87  | 25 | 23.825 | 12.065 | 7.70  |
|  | MTA3 B16 <small>NEW</small> | 119 | 87  | 32 | 23.825 | 15.733 | 7.70  |
|  | MTA3 B18 <small>NEW</small> | 127 | 87  | 40 | 23.825 | 15.733 | 7.70  |
|  | MTA4 B16 <small>NEW</small> | 141 | 110 | 32 | 31.267 | 15.733 | 9.20  |
|  | MTA4 B18 <small>NEW</small> | 150 | 110 | 40 | 31.267 | 17.780 | 9.30  |
|  | MTA5 B16 <small>NEW</small> | 165 | 137 | 32 | 44.399 | 17.733 | 18.50 |
|  | MTA5 B18 <small>NEW</small> | 175 | 135 | 40 | 44.399 | 17.780 | 18.50 |
|  | MTA5 B22 <small>NEW</small> | 185 | 138 | 48 | 44.399 | 21.793 | 19.00 |









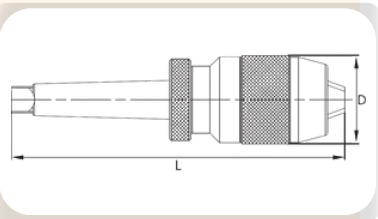

**MORSE TAPER REDUCTION SLEEVE DIN2185**  
Mors Konik Redüksiyon Kovanlar

|                                                                                     | CODE / KOD<br>MT | Outside Taper<br>Dış Konik | Inside Taper<br>İç Konik | L   | EURO  |
|-------------------------------------------------------------------------------------|------------------|----------------------------|--------------------------|-----|-------|
|    | MT2 MT1          | MT2                        | MT1                      | 92  | 6.60  |
|    | MT3 MT1          | MT3                        | MT1                      | 99  | 7.20  |
|    | MT3 MT2          | MT3                        | MT2                      | 112 | 6.60  |
|    | MT4 MT1          | MT4                        | MT1                      | 124 | 10.00 |
|    | MT4 MT2          | MT4                        | MT2                      | 124 | 9.00  |
|    | MT4 MT3          | MT4                        | MT3                      | 140 | 8.80  |
|    | MT5 MT1          | MT5                        | MT1                      | 156 | 16.50 |
|    | MT5 MT2          | MT5                        | MT2                      | 156 | 15.50 |
|    | MT5 MT3          | MT5                        | MT3                      | 156 | 15.00 |
|    | MT5 MT4          | MT5                        | MT4                      | 171 | 15.00 |
|    | MT6 MT2          | MT6                        | MT2                      | 218 | 45.00 |
|    | MT6 MT3          | MT6                        | MT3                      | 218 | 44.00 |
|   | MT6 MT4          | MT6                        | MT4                      | 218 | 43.00 |
|  | MT6 MT5          | MT6                        | MT5                      | 218 | 43.00 |

**DRILL CHUCK HOLDERS**  
MANDRENLİ TUTUCU





**DIN228 B MORSE TAPER / MORS KONİK**

|                                                                                     | CODE / KOD<br>MT | Ø    | D  | L   | EURO  |
|-------------------------------------------------------------------------------------|------------------|------|----|-----|-------|
|  | MT2 DC13         | 1-13 | 51 | 185 | 69.00 |
|  | MT2 DC16         | 3-16 | 55 | 190 | 72.00 |
|  | MT3 DC13         | 1-13 | 51 | 205 | 71.00 |
|  | MT3 DC16         | 3-16 | 55 | 210 | 74.00 |
|  | MT4 DC13         | 1-13 | 51 | 210 | 74.00 |
|  | MT4 DC16         | 3-16 | 55 | 235 | 79.00 |

**MORSE TAPER TANG DAPTOR**  
Mors Konik Çakma Dil Adaptörü



|                                                                                     | CODE / KOD<br>MTB | MORSE TAPER SHANK<br>ER Pens Başlıkları | M        | EURO  |
|-------------------------------------------------------------------------------------|-------------------|-----------------------------------------|----------|-------|
|  | TANGMT2           | MT2 TANG FOR DIN 228A                   | M10x1.5  | 10.00 |
|  | TANGMT3           | MT3 TANG FOR DIN228A                    | M12x1.75 | 11.00 |
|  | TANGMT4           | MT4 TANG FOR DIN 228A                   | M16x2    | 12.00 |





LIVE CENTRES  
DRILL CHUCKS  
SOLID CENTRES  
CYLINDRICAL REDUCTION SLEEVES  
DÖNER PUNTALAR  
MATKAP MANDRENLERİ  
SABİT PUNTALAR  
SİLİNDİRİK REDÜKSİYON KOVANLAR

**PRECISION CNC LIVE CENTRES  
HASSAS CNC DÖNER PUNTALAR**

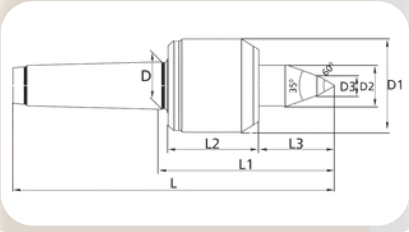
**PRECISION CNC LIVE CENTRES  
HASSAS CNC DÖNER PUNTALAR**





|                                                                                   | CODE /<br>KOD<br>LCMT | Taper<br>Konik | D      | D1 | D2 | D3 | L     | L1  | L2 | L3 | Max<br>Rpm<br>Devir | EURO   |
|-----------------------------------------------------------------------------------|-----------------------|----------------|--------|----|----|----|-------|-----|----|----|---------------------|--------|
|  | LCMT3                 | MT3            | 23.825 | 53 | 22 | 10 | 184   | 103 | 42 | 54 | 8000                | 160.00 |
|  | LCMT4                 | MT4            | 31.267 | 63 | 28 | 12 | 225.5 | 124 | 53 | 64 | 6000                | 180.00 |
|  | LCMT5                 | MT5            | 44.399 | 83 | 38 | 16 | 284   | 155 | 63 | 79 | 4000                | 200.00 |

**PRECISION CNC LIVE CENTRES XP EXTENDED POINT  
HASSAS CNC DÖNER PUNTALAR XP UZUN BURUNLU**

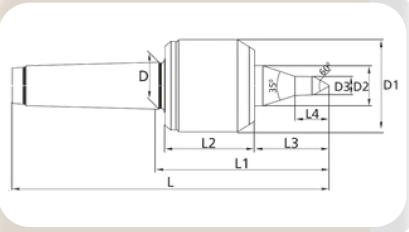
**PRECISION CNC LIVE CENTRES XP EXTENDED POINT  
HASSAS CNC DÖNER PUNTALAR XP UZUN BURUNLU**







|                                                                                     | CODE /<br>KOD<br>LCMT | Taper<br>Konik | D      | D1 | D2 | D3 | L     | L1  | L2 | L3   | L4 | Max<br>Rpm<br>Devir | EURO   |
|-------------------------------------------------------------------------------------|-----------------------|----------------|--------|----|----|----|-------|-----|----|------|----|---------------------|--------|
|  | LCMT3XP               | MT3            | 23.825 | 53 | 22 | 10 | 184   | 103 | 42 | 54   | 15 | 8000                | 160.00 |
|  | LCMT4XP               | MT4            | 31.267 | 63 | 28 | 14 | 225.5 | 124 | 53 | 64   | 25 | 6000                | 180.00 |
|  | LCMT5XP               | MT5            | 44.399 | 83 | 38 | 16 | 284   | 155 | 69 | 79.5 | 25 | 4000                | 200.00 |







**PRECISION SOLID CENTRE  
HASSAS SABİT PUNTA**

**DIN 806**









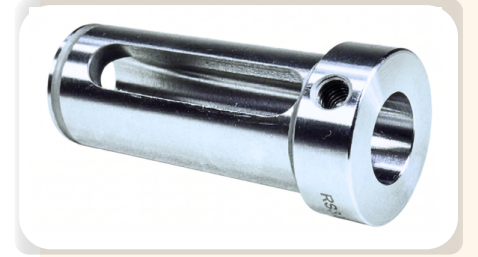

|                                                                                     | CODE / KOD<br>SC806 | Taper<br>Konik | D    | D1  | EURO  |
|-------------------------------------------------------------------------------------|---------------------|----------------|------|-----|-------|
|  | SC806MT2            | MT2            | 18   | 100 | 25.00 |
|  | SC806MT3            | MT3            | 24.1 | 125 | 27.00 |
|  | SC806MT4            | MT4            | 31.6 | 160 | 35.00 |
|  | SC806MT5            | MT5            | 44.7 | 200 | 65.00 |

RS20 Reduction Sleeves  
RS20 Redüksiyon Kovanları

|                                                                                   | CODE / KOD<br>RS | D  | D1 | L  | FORM   | EURO  |
|-----------------------------------------------------------------------------------|------------------|----|----|----|--------|-------|
|  | RS2006           | 20 | 6  | 62 | FORM 1 | 18.00 |
|  | RS2008           | 20 | 8  | 62 | FORM 1 | 18.00 |
|  | RS2010           | 20 | 10 | 62 | FORM 1 | 18.00 |
|  | RS2012           | 20 | 12 | 62 | FORM 2 | 18.00 |
|  | RS2014           | 20 | 14 | 62 | FORM 2 | 18.00 |
|  | RS2016           | 20 | 16 | 62 | FORM 2 | 18.00 |



RS25 Reduction Sleeves  
RS25 Redüksiyon Kovanları

|                                                                                     | CODE / KOD<br>RS | D  | D1 | L  | FORM   | EURO  |
|-------------------------------------------------------------------------------------|------------------|----|----|----|--------|-------|
|  | RS2506           | 25 | 6  | 63 | FORM 1 | 18.00 |
|  | RS2508           | 25 | 8  | 63 | FORM 1 | 18.00 |
|  | RS2510           | 25 | 10 | 63 | FORM 1 | 18.00 |
|  | RS2512           | 25 | 12 | 63 | FORM 2 | 18.00 |
|  | RS2514           | 25 | 14 | 63 | FORM 2 | 18.00 |
|  | RS2516           | 25 | 16 | 63 | FORM 2 | 18.00 |
|  | RS2518           | 25 | 18 | 63 | FORM 2 | 18.00 |
|  | RS2520           | 25 | 20 | 63 | FORM 2 | 18.00 |

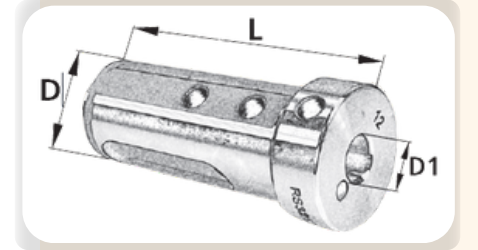

RS25 Reduction Sleeve Kit  
RS25 Redüksiyon Kovan Seti







|                                                                                     | CODE / KOD<br>RS | Content<br>İçeriği           | EURO   |
|-------------------------------------------------------------------------------------|------------------|------------------------------|--------|
|  | RS25SET6         | Ø6mm-8mm-10mm-12mm-16mm-20mm | 128.00 |

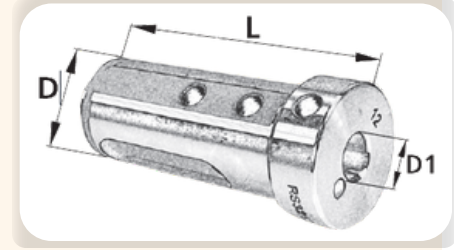



**RS32 Reduction Sleeves**  
**RS32 Redüksiyon Kovanları**



|                                                                                    | CODE / KOD<br>RS | D  | D1 | L  | FORM   | EURO  |
|------------------------------------------------------------------------------------|------------------|----|----|----|--------|-------|
|   | RS3206           | 32 | 6  | 89 | FORM 1 | 19.50 |
|   | RS3208           | 32 | 8  | 89 | FORM 1 | 19.50 |
|   | RS3210           | 32 | 10 | 89 | FORM 1 | 19.50 |
|   | RS3212           | 32 | 12 | 89 | FORM 1 | 19.50 |
|   | RS3214           | 32 | 14 | 89 | FORM 1 | 19.50 |
|   | RS3216           | 32 | 16 | 89 | FORM 1 | 19.50 |
|   | RS3218           | 32 | 18 | 89 | FORM 2 | 19.50 |
|   | RS3220           | 32 | 20 | 89 | FORM 2 | 19.50 |
|  | RS3225           | 32 | 25 | 89 | FORM 2 | 19.50 |













**RS32 Reduction Sleeve Kit**  
**RS32 Redüksiyon Kovan Seti**



|                                                                                     | CODE / KOD<br>RS | Content<br>İçeriği                | EURO   |
|-------------------------------------------------------------------------------------|------------------|-----------------------------------|--------|
|  | RS32SET7         | Ø6mm-8mm-10mm-12mm-16mm-20mm-25mm | 165.00 |

RS40 Reduction Sleeves  
RS40 Redüksiyon Kovanları

|                                                                                   | CODE / KOD<br>RS | D  | D1 | L   | FORM   | EURO  |
|-----------------------------------------------------------------------------------|------------------|----|----|-----|--------|-------|
|  | RS4006           | 40 | 6  | 100 | FORM 1 | 21.00 |
|  | RS4008           | 40 | 8  | 100 | FORM 1 | 21.00 |
|  | RS4010           | 40 | 10 | 100 | FORM 1 | 21.00 |
|  | RS4012           | 40 | 12 | 100 | FORM 1 | 21.00 |
|  | RS4014           | 40 | 14 | 100 | FORM 1 | 21.00 |
|  | RS4016           | 40 | 16 | 100 | FORM 1 | 21.00 |
|  | RS4018           | 40 | 18 | 100 | FORM 1 | 21.00 |
|  | RS4020           | 40 | 20 | 100 | FORM 1 | 21.00 |
|  | RS4025           | 40 | 25 | 100 | FORM 2 | 21.00 |
|  | RS4032           | 40 | 32 | 100 | FORM 2 | 21.00 |

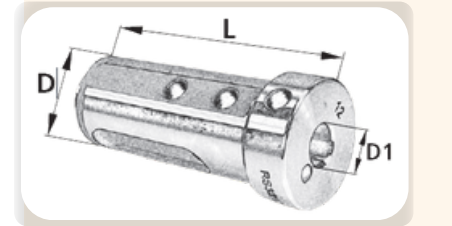

















RS40 Reduction Sleeve Kit  
RS40 Redüksiyon Kovan Seti

|                                                                                     | CODE / KOD<br>RS | Content<br>İçeriği                     | EURO   |
|-------------------------------------------------------------------------------------|------------------|----------------------------------------|--------|
|  | RS40SET8         | Ø6mm-8mm-10mm-12mm-16mm-20mm-25mm-32mm | 197.00 |







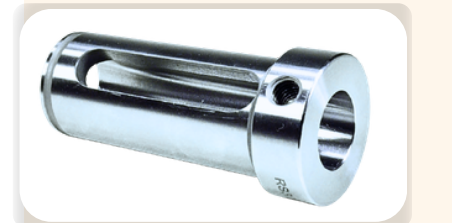

RS50 Reduction Sleeves  
RS50 Redüksiyon Kovanları

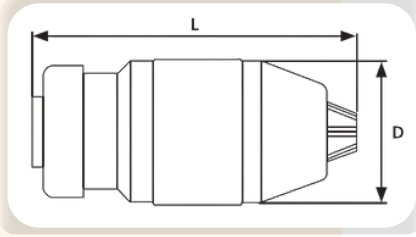
|                                                                                    | CODE / KOD<br>RS                                                                           | D  | D1 | L   | FORM   | EURO  |
|------------------------------------------------------------------------------------|--------------------------------------------------------------------------------------------|----|----|-----|--------|-------|
|  | RS5008  | 50 | 8  | 110 | FORM 1 | 28.00 |
|  | RS5010  | 50 | 10 | 110 | FORM 1 | 28.00 |
|  | RS5012  | 50 | 12 | 110 | FORM 1 | 28.00 |
|  | RS5016  | 50 | 16 | 110 | FORM 1 | 28.00 |
|  | RS5020  | 50 | 20 | 110 | FORM 1 | 28.00 |
|  | RS5025  | 50 | 25 | 110 | FORM 2 | 28.00 |
|  | RS5032  | 50 | 32 | 110 | FORM 2 | 28.00 |
|  | RS5040  | 50 | 40 | 110 | FORM 2 | 28.00 |



## SELF CENTERING DRILL CHUCK ELLE SIKMA MATKAP MANDRENİ





|                                                                                   | CODE / KOD<br>DC | L   | D  | Clamping<br>Range<br>Sıkma Aralığı | Inner Rear<br>Taper<br>Arka Konik | EURO  |
|-----------------------------------------------------------------------------------|------------------|-----|----|------------------------------------|-----------------------------------|-------|
|  | DC10 B12         | 82  | 42 | 1-10MM                             | B12                               | 19.50 |
|  | DC13 B12         | 96  | 49 | 1-13MM                             | B12                               | 21.00 |
|  | DC13 B16         | 96  | 49 | 1-13MM                             | B16                               | 21.00 |
|  | DC16 B16         | 105 | 54 | 3-16MM                             | B16                               | 24.00 |
|  | DC16 B18         | 105 | 54 | 3-16MM                             | B18                               | 24.00 |
|  | DC20 B22         | 120 | 62 | 5-20MM                             | B22                               | 38.00 |

## DIN 238 B TAPERED COLLET CHUCK DIN 238 B KONİKLİ PENS BAŞLIĞI





SUITABLE FOR B16 - B18 DRILL TAPER / B16 - B18 Matkap Koniğine Uygun

|                                                                                     | CODE / KOD<br>RS | Inner Rear Taper<br>Arka Konik | Collet<br>Pens | Clamping Range<br>Sıkma Aralığı | EURO  |
|-------------------------------------------------------------------------------------|------------------|--------------------------------|----------------|---------------------------------|-------|
|  | B16 ER25         | B 16                           | ER25           | 2-16MM                          | 29.00 |
|  | B18 ER32         | B 18                           | ER32           | 3-20MM                          | 30.00 |

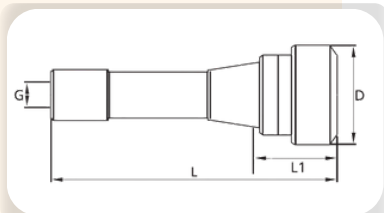
## R8 (BRIDGEPORT) ER COLLET CHUCKS R8 (BRIDGEPORT) ER PENS BAŞLIKLARI









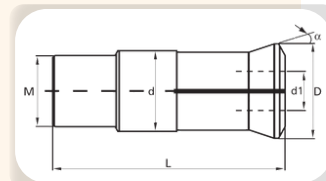
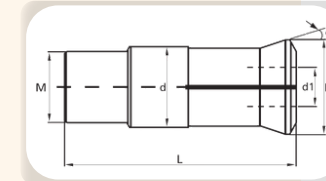
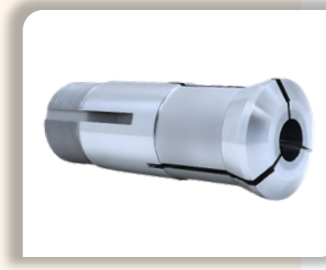
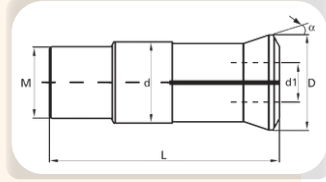
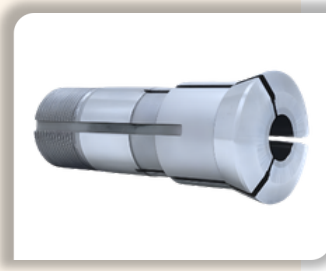
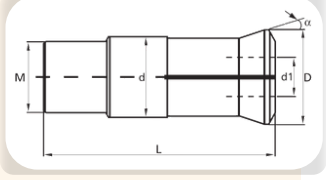



|                                                                                     | CODE / KOD<br>RS | L   | L1 | D  | G           | EURO  |
|-------------------------------------------------------------------------------------|------------------|-----|----|----|-------------|-------|
|  | R8 ER32          | 160 | 60 | 50 | 7/16x20 UNF | 34.00 |
|  | R8 ER40          | 170 | 70 | 63 | 7/16x20 UNF | 36.00 |













**GUIDE BUSHES WITH CARBIDE BORE**  
**YATAKLAMA SÜRÜCÜ PENSLER KARBÜR DELİKLİ**



|                                                                                   | CODE / KOD<br>F853         | D1 RANGE<br>Ø2-13mm | d  | D  | L  | M     | $\alpha$ | EURO   |
|-----------------------------------------------------------------------------------|----------------------------|---------------------|----|----|----|-------|----------|--------|
|  | F853..R <small>NEW</small> | 2-3-4-5mm           | 18 | 22 | 59 | M16X1 | 30°      | 115.00 |
|  | F853..R <small>NEW</small> | 6-7-8mm             | 18 | 22 | 59 | M16X1 | 30°      | 125.00 |
|  | F853..R <small>NEW</small> | 9-10-11mm           | 18 | 22 | 59 | M16X1 | 30°      | 135.00 |
|  | F853..R <small>NEW</small> | 12-13mm             | 18 | 22 | 59 | M16X1 | 30°      | 145.00 |

|                                                                                     | CODE / KOD<br>F391         | D1 RANGE<br>Ø2-18mm | d  | D  | L  | M     | $\alpha$ | EURO   |
|-------------------------------------------------------------------------------------|----------------------------|---------------------|----|----|----|-------|----------|--------|
|    | F391..R <small>NEW</small> | 2-3-4-5mm           | 22 | 29 | 68 | M22X1 | 16°      | 115.00 |
|    | F391..R <small>NEW</small> | 6-7-8mm             | 22 | 29 | 68 | M22X1 | 16°      | 125.00 |
|   | F391..R <small>NEW</small> | 9-10-11mm           | 22 | 29 | 68 | M22X1 | 16°      | 135.00 |
|  | F391..R <small>NEW</small> | 12-13-14mm          | 22 | 29 | 68 | M22X1 | 16°      | 145.00 |
|  | F391..R <small>NEW</small> | 15-16-17mm          | 22 | 29 | 68 | M22X1 | 16°      | 160.00 |
|  | F391..R <small>NEW</small> | 18mm                | 22 | 29 | 68 | M22X1 | 16°      | 185.00 |

|                                                                                     | CODE / KOD<br>TD26         | D1 RANGE<br>Ø2-20mm | d  | D  | L  | M     | $\alpha$ | EURO   |
|-------------------------------------------------------------------------------------|----------------------------|---------------------|----|----|----|-------|----------|--------|
|  | TD26..R <small>NEW</small> | 2-3-4-5mm           | 26 | 29 | 77 | M25X1 | 16°      | 115.00 |
|  | TD26..R <small>NEW</small> | 6-7-8mm             | 26 | 29 | 77 | M25X1 | 16°      | 125.00 |
|  | TD26..R <small>NEW</small> | 9-10-11mm           | 26 | 29 | 77 | M25X1 | 16°      | 135.00 |
|  | TD26..R <small>NEW</small> | 12-13-14mm          | 26 | 29 | 77 | M25X1 | 16°      | 145.00 |
|  | TD26..R <small>NEW</small> | 15-16-17mm          | 26 | 29 | 77 | M25X1 | 16°      | 160.00 |
|  | TD26..R <small>NEW</small> | 18-19-20mm          | 26 | 29 | 77 | M25X1 | 16°      | 185.00 |

|                                                                                     | CODE / KOD<br>I357         | D1 RANGE<br>Ø2-21mm | d  | D  | L  | M     | $\alpha$ | EURO   |
|-------------------------------------------------------------------------------------|----------------------------|---------------------|----|----|----|-------|----------|--------|
|  | I357..R <small>NEW</small> | 2-3-4-5mm           | 28 | 38 | 81 | M25X1 | 30°      | 120.00 |
|  | I357..R <small>NEW</small> | 6-7-8mm             | 28 | 38 | 81 | M25X1 | 30°      | 130.00 |
|  | I357..R <small>NEW</small> | 9-10-11mm           | 28 | 38 | 81 | M25X1 | 30°      | 140.00 |
|  | I357..R <small>NEW</small> | 12-13-14mm          | 28 | 38 | 81 | M25X1 | 30°      | 150.00 |
|  | I357..R <small>NEW</small> | 15-16-17mm          | 28 | 38 | 81 | M25X1 | 30°      | 165.00 |
|  | I357..R <small>NEW</small> | 18-19-20mm          | 28 | 38 | 81 | M25X1 | 30°      | 185.00 |
|  | I357..R <small>NEW</small> | 21mm                | 28 | 38 | 81 | M25X1 | 30°      | 195.00 |

**GUIDE BUSHES WITH CARBIDE BORE**  
**YATAKLAMA SÜRÜCÜ PENSLER KARBÜR DELİKLİ**

|  | CODE / KOD<br>T223 | D1 RANGE<br>Ø2-20mm | d  | D  | L  | M     | $\alpha$ | EURO   |
|--|--------------------|---------------------|----|----|----|-------|----------|--------|
|  | T223..R            | 2-3-4-5mm           | 28 | 34 | 82 | M25X1 | 16°      | 115.00 |
|  | T223..R            | 6-7-8mm             | 28 | 34 | 82 | M25X1 | 16°      | 125.00 |
|  | T223..R            | 9-10-11mm           | 28 | 34 | 82 | M25X1 | 16°      | 135.00 |
|  | T223..R            | 12-13-14mm          | 28 | 34 | 82 | M25X1 | 16°      | 145.00 |
|  | T223..R            | 15-16-17mm          | 28 | 34 | 82 | M25X1 | 16°      | 160.00 |
|  | T223..R            | 18-19-20mm          | 28 | 34 | 82 | M25X1 | 16°      | 185.00 |

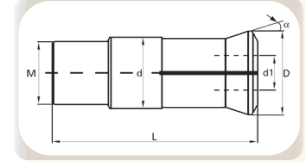
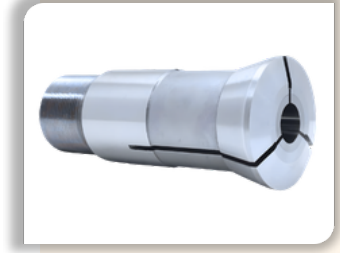

|  | CODE / KOD<br>T227 | D1 RANGE<br>Ø2-25mm | d  | D  | L  | M     | $\alpha$ | EURO   |
|--|--------------------|---------------------|----|----|----|-------|----------|--------|
|  | T227..R <b>NEW</b> | 2-3-4-5mm           | 34 | 41 | 87 | M34X1 | 10°      | 125.00 |
|  | T227..R <b>NEW</b> | 6-7-8mm             | 34 | 41 | 87 | M34X1 | 10°      | 135.00 |
|  | T227..R <b>NEW</b> | 9-10-11mm           | 34 | 41 | 87 | M34X1 | 10°      | 145.00 |
|  | T227..R <b>NEW</b> | 12-13-14mm          | 34 | 41 | 87 | M34X1 | 10°      | 155.00 |
|  | T227..R <b>NEW</b> | 15-16-17mm          | 34 | 41 | 87 | M34X1 | 10°      | 165.00 |
|  | T227..R <b>NEW</b> | 18-19-20mm          | 34 | 41 | 87 | M34X1 | 10°      | 185.00 |
|  | T227..R <b>NEW</b> | 21-22-23mm          | 34 | 41 | 87 | M34X1 | 10°      | 195.00 |
|  | T227..R <b>NEW</b> | 24-25mm             | 34 | 41 | 87 | M34X1 | 10°      | 205.00 |

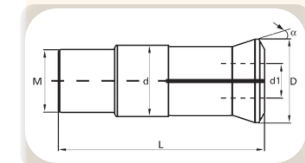
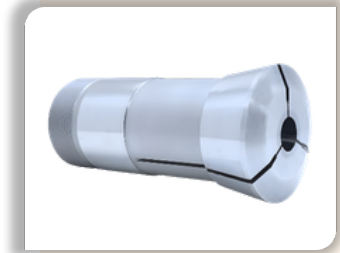

|  | CODE / KOD<br>T229 | D1 RANGE<br>Ø3-32mm | d  | D  | L  | M     | $\alpha$ | EURO   |
|--|--------------------|---------------------|----|----|----|-------|----------|--------|
|  | T229..R <b>NEW</b> | 2-3-4-5-6-7mm       | 42 | 49 | 82 | M40X1 | 16°      | 145.00 |
|  | T229..R <b>NEW</b> | 8-9-10-11-12mm      | 42 | 49 | 82 | M40X1 | 16°      | 160.00 |
|  | T229..R <b>NEW</b> | 13-14-15--16-17mm   | 42 | 49 | 82 | M40X1 | 16°      | 175.00 |
|  | T229..R <b>NEW</b> | 18-19-20-21-22mm    | 42 | 49 | 82 | M40X1 | 16°      | 195.00 |
|  | T229..R <b>NEW</b> | 23-24-25-26-27mm    | 42 | 49 | 82 | M40X1 | 16°      | 215.00 |
|  | T229..R <b>NEW</b> | 28-29-30-31-32mm    | 42 | 49 | 82 | M40X1 | 16°      | 235.00 |

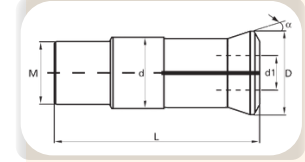

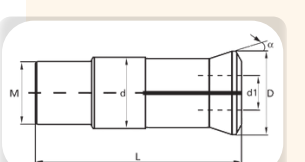

|  | CODE / KOD<br>T249 | D1 RANGE<br>Ø4-38mm | d  | D  | L  | M     | $\alpha$ | EURO   |
|--|--------------------|---------------------|----|----|----|-------|----------|--------|
|  | T249..R <b>NEW</b> | 4-5-6-7mm           | 48 | 54 | 81 | M46X1 | 10°      | 160.00 |
|  | T249..R <b>NEW</b> | 8-9-10-11-12mm      | 48 | 54 | 81 | M46X1 | 10°      | 170.00 |
|  | T249..R <b>NEW</b> | 13-14-15-16-17mm    | 48 | 54 | 81 | M46X1 | 10°      | 185.00 |
|  | T249..R <b>NEW</b> | 18-19-20-21-22mm    | 48 | 54 | 81 | M46X1 | 10°      | 200.00 |
|  | T249..R <b>NEW</b> | 23-24-25-26-27mm    | 48 | 54 | 81 | M46X1 | 10°      | 225.00 |
|  | T249..R <b>NEW</b> | 28-29-30-31-32mm    | 48 | 54 | 81 | M46X1 | 10°      | 250.00 |
|  | T249..R <b>NEW</b> | 33-34-35mm          | 48 | 54 | 81 | M46X1 | 10°      | 280.00 |
|  | T249..R <b>NEW</b> | 36-37-38mm          | 48 | 54 | 81 | M46X1 | 10°      | 310.00 |





**DIN 6388 / ISO 10897 401E (OZ8) & 468E (OZ40) COLLETS**  
**DIN 6388 / ISO 10897 401E (OZ8) ve 468E (OZ40) Pensler**

































**401E (OZ8-A) COLLETS**  
**401E (OZ8-A) Pensler**

|                                                                                  | CODE / KOD<br>OZ08 |                                                                                   | Clamping Dia Ø mm<br>Sıkma Çapı Ø mm | EURO  |
|----------------------------------------------------------------------------------|--------------------|-----------------------------------------------------------------------------------|--------------------------------------|-------|
|  | OZ080102           |  | 1mm                                  | 17.00 |
|  | OZ080202           |  | 2mm                                  | 16.00 |
|  | OZ080302           |  | 3mm                                  | 14.00 |
|  | OZ080402           |  | 4mm                                  | 14.00 |
|  | OZ080502           |  | 5mm                                  | 14.00 |
|  | OZ080602           |  | 6mm                                  | 14.00 |
|  | OZ080702           |  | 7mm                                  | 14.00 |
|  | OZ080802           |  | 8mm                                  | 14.00 |



| OZ08                            |           |
|---------------------------------|-----------|
| D                               | 15mm      |
| L                               | 26mm      |
| a                               | 20 51'45" |
| β                               | 30°       |
| Clamping Range<br>Tutma Aralığı | 1-8mm     |

**468E (OZ40-B) COLLETS**  
**468E (OZ40-B) Pensler**

|                                                                                    | CODE / KOD<br>OZ40 |                                                                                     | Clamping Dia Ø mm<br>Sıkma Çapı Ø mm | EURO  |
|------------------------------------------------------------------------------------|--------------------|-------------------------------------------------------------------------------------|--------------------------------------|-------|
|  | OZ401202           |  | 12mm                                 | 31.00 |
|  | OZ401402           |  | 14mm                                 | 31.00 |
|  | OZ401602           |  | 16mm                                 | 31.00 |
|  | OZ401802           |  | 18mm                                 | 31.00 |
|  | OZ402002           |  | 20mm                                 | 31.00 |
|  | OZ402202           |  | 22mm                                 | 31.00 |
|  | OZ402402           |  | 24mm                                 | 31.00 |
|  | OZ402502           |  | 25mm                                 | 31.00 |
|  | OZ402602           |  | 26mm                                 | 31.00 |
|  | OZ402802           |  | 28mm                                 | 31.00 |
|  | OZ403002           |  | 30mm                                 | 31.00 |
|  | OZ403202           |  | 32mm                                 | 31.00 |
|  | OZ403402           |  | 34mm                                 | 31.00 |
|  | OZ403602           |  | 36mm                                 | 31.00 |
|  | OZ403802           |  | 38mm                                 | 31.00 |
|  | OZ404002           |  | 40mm                                 | 31.00 |





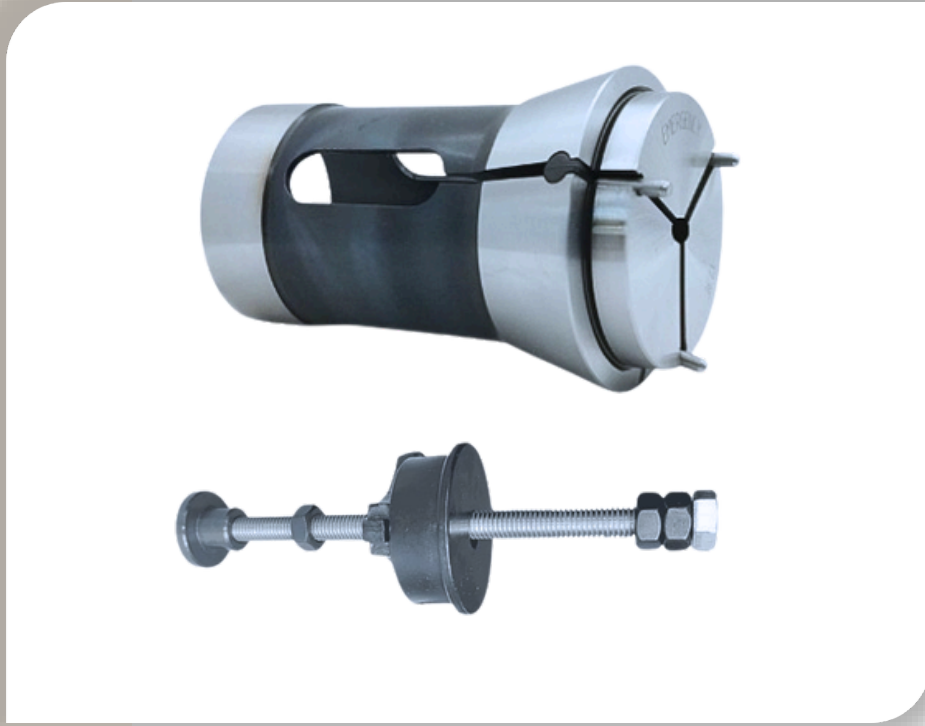





| OZ40                               |           |
|------------------------------------|-----------|
| D                                  | 52mm      |
| L                                  | 68mm      |
| a                                  | 20 51'45" |
| β                                  | 30°       |
| CLAMPING RANGE<br>Tutma Aralığı    | 12-40mm   |
| CLAMPING STEPS<br>Tutma Kapasitesi | 0.5mm     |





**DIN 6343 EMERGENCY COLLETS**  
**DIN 6343 Yumuşak İşlenebilir Pensler**  
**DIN 6343 ADJUSTABLE COLLET STOPS**  
**DIN 6343 Ayarlı Pens Dayamaları**

**DIN 6343 EMERGENCY COLLETS**  
**DIN 6343 Yumuşak İşlenebilir Pensler**

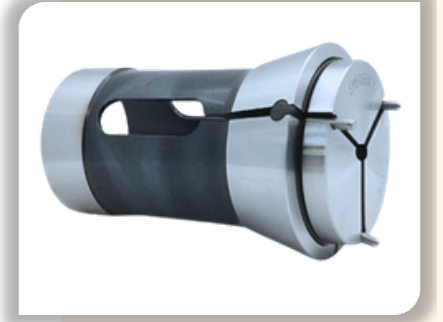
|                                                                                  | CODE / KOD<br>EMER          | EURO  |
|----------------------------------------------------------------------------------|-----------------------------|-------|
|  | EMER145E <small>NEW</small> | 46.00 |
|  | EMER148E <small>NEW</small> | 47.00 |
|  | EMER161E <small>NEW</small> | 50.00 |
|  | EMER163E <small>NEW</small> | 60.00 |
|  | EMER171E <small>NEW</small> | 75.00 |
|  | EMER173E <small>NEW</small> | 75.00 |
|  | EMER177E <small>NEW</small> | 95.00 |
|  | EMER185E <small>NEW</small> | 95.00 |



**DIN 6343 ADJUSTABLE COLLET STOPS**  
**DIN 6343 Ayarlı Pens Dayamaları**

|                                                                                     | CODE / KOD<br>CST          | EURO   |
|-------------------------------------------------------------------------------------|----------------------------|--------|
|  | CST173E <small>NEW</small> | 100.00 |
|  | CST185E <small>NEW</small> | 115.00 |

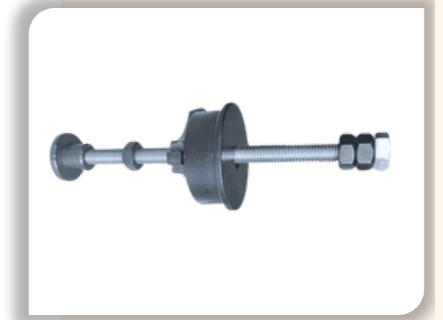







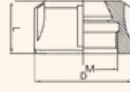

**TOOLHOLDER ACCESSORIES  
TUTUCU AKSESUARLARI**



ER STANDARD LOCKNUT / ER Standard Somun  
DIN 6499 / ISO 15488



|                                                                                  | CODE / KOD<br>NER | ER SIZE / ER Ölçüsü | D  | L    | M       | EURO  |
|----------------------------------------------------------------------------------|-------------------|---------------------|----|------|---------|-------|
|  | NER16S            | ER16                | 32 | 17.5 | M22X1.5 | 5.50  |
|  | NER20S            | ER20                | 35 | 19   | M25X1.5 | 5.50  |
|  | NER25S            | ER25                | 42 | 20   | M32X1.5 | 5.80  |
|  | NER32S            | ER32                | 50 | 22.5 | M40X1.5 | 6.00  |
|  | NER40S            | ER40                | 63 | 25.5 | M50X1.5 | 7.90  |
|  | NER50S            | ER50                | 78 | 35   | M64X2   | 14.50 |

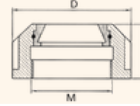



ER BEARING TYPE LOCKNUT / ER Bilyalı Tip Somun  
DIN 6499 / ISO 15488

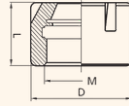

|                                                                                    | CODE / KOD<br>NER | ER SIZE / ER Ölçüsü | D  | L    | M       | EURO  |
|------------------------------------------------------------------------------------|-------------------|---------------------|----|------|---------|-------|
|  | NER25B            | ER25                | 42 | 23   | M32X1.5 | 15.50 |
|  | NER32B            | ER32                | 50 | 25   | M40X1.5 | 15.50 |
|  | NER40B            | ER40                | 63 | 28.5 | M50X1.5 | 16.50 |

ER MINI LOCKNUT / ER Mini Somun  
DIN 6499 / ISO 15488





|                                                                                    | CODE / KOD<br>NER | ER SIZE / ER Ölçüsü | D  | L  | M        | EURO |
|------------------------------------------------------------------------------------|-------------------|---------------------|----|----|----------|------|
|  | NER08M            | ER 8 MINI           | 12 | 11 | M10x0.75 | 6.00 |
|  | NER11M            | ER 11 MINI          | 16 | 12 | M13x0.75 | 5.50 |
|  | NER16M            | ER 16 MINI          | 22 | 19 | M19x1    | 5.50 |
|  | NER20M            | ER 20 MINI          | 28 | 19 | M24x1    | 5.60 |
|  | NER25M            | ER 25 MINI          | 35 | 20 | M30x1    | 5.90 |

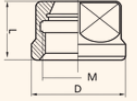

**ER HEXAGON LOCKNUT / ER Altıköşe Somun**  
DIN 6499 / ISO 15488





|                                                                                   | CODE / KOD<br>NER | ER SIZE / ER Ölçüsü | D  | L    | M        | EURO |
|-----------------------------------------------------------------------------------|-------------------|---------------------|----|------|----------|------|
|  | NER11H            | ER11                | 19 | 11,3 | M14x0.75 | 5.50 |
|  | NER16H            | ER16                | 28 | 17   | M22x1.5  | 5.50 |
|  | NER20H            | ER20                | 34 | 19   | M25x1.5  | 5.60 |

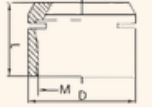

**ER HIGH SPEED LOCKNUT (Suitable for ER MINI Toolholders)**  
ER Yüksek Hız Somunu (ER MINI tutuculara uygundur)







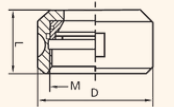

|                                                                                    | CODE / KOD<br>NER | ER SIZE / ER Ölçüsü | D  | L  | M        | EURO  |
|------------------------------------------------------------------------------------|-------------------|---------------------|----|----|----------|-------|
|   | NER11HS           | ER11 MINI           | 16 | 12 | M13x0.75 | 11.80 |
|   | NER16HS           | ER16 MINI           | 22 | 18 | M19x1    | 11.80 |
|  | NER20HS           | ER20 MINI           | 28 | 19 | M24x1    | 11.80 |



**OZ TYPE LOCKNUT / OZ Tip Somun**  
DIN 6388 / ISO 10897-D







|                                                                                     | CODE / KOD<br>NOZ | ER SIZE / ER Ölçüsü | D  | L  | M       | EURO  |
|-------------------------------------------------------------------------------------|-------------------|---------------------|----|----|---------|-------|
|  | NOZ08             | OZ 8                | 26 | 19 | M18x1.5 | 24.00 |
|  | NOZ12             | OZ12 407E           | 35 | 20 | M27x1,5 | 24.00 |
|  | NOZ16B            | OZ16 410E-415E      | 43 | 24 | M33X1.5 | 24.00 |
|  | NOZ20B            | OZ20 4541E          | 50 | 28 | M42X2   | 24.00 |
|  | NOZ25B            | OZ25 444E-462E      | 60 | 30 | M48X2   | 18.00 |
|  | NOZ32B            | OZ32 450E-467E      | 72 | 34 | M60X2.5 | 25.00 |
|  | NOZ40B            | OZ 40               | 86 | 73 | M65x2.5 | 48.00 |

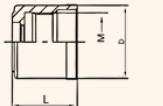







**LOCKNUTS FOR SK COLLET CHUCKS**  
SK Pens Başlıkları için Somunlar





|                                                                                     | CODE / KOD<br>NSK | SK SIZE / SK Ölçüsü | D     | L  | M       | EURO  |
|-------------------------------------------------------------------------------------|-------------------|---------------------|-------|----|---------|-------|
|  | NSK06             | SK06                | 19.50 | 21 | M15X1   | 7.50  |
|  | NSK10             | SK10                | 27    | 24 | M22X1   | 7.50  |
|  | NSK13             | SK13                | 33    | 27 | M27X1   | 7.50  |
|  | NSK16             | SK16                | 40    | 31 | M32X1.5 | 8.50  |
|  | NSK20             | SK20                | 48    | 30 | M40X1   | 10.00 |

**ER STANDARD SPANNER / ER Standart Anahtar**

|                                                                                  | CODE / KOD<br>SPER | ER SIZE / ER Ölçüsü | EURO  |
|----------------------------------------------------------------------------------|--------------------|---------------------|-------|
|  | SPER16S            | ER16                | 4.50  |
|  | SPER20S            | ER20                | 4.50  |
|  | SPER25S            | ER25                | 4.80  |
|  | SPER32S            | ER32                | 5.30  |
|  | SPER40S            | ER40                | 6.60  |
|  | SPER50S            | ER50                | 14.50 |







**ER MOON TYPE SPANNER / ER Ay Tipi Anahtar**

|                                                                                    | CODE / KOD<br>SPER | ER SIZE / ER Ölçüsü | EURO |
|------------------------------------------------------------------------------------|--------------------|---------------------|------|
|    | SPER25C            | ER25                | 4.80 |
|   | SPER32C            | ER32                | 5.30 |
|  | SPER40C            | ER40                | 6.60 |





**ER MINI SPANNER / ER MINI Anahtar**

|                                                                                    | CODE / KOD<br>SPER | ER SIZE / ER Ölçüsü | EURO |
|------------------------------------------------------------------------------------|--------------------|---------------------|------|
|  | SPER08M            | ER 8 MINI           | 5.50 |
|  | SPER11M            | ER 11 MINI          | 5.50 |
|  | SPER16M            | ER 16 MINI          | 5.50 |
|  | SPER20M            | ER 20 MINI          | 6.20 |
|  | SPER25M            | ER 25 MINI          | 6.90 |







**ER HEXAGON SPANNER / ER Altıköşe Anahtar**

|                                                                                    | CODE / KOD<br>SPER | ER SIZE / ER Ölçüsü | EURO |
|------------------------------------------------------------------------------------|--------------------|---------------------|------|
|  | SPER11H            | ER 11               | 3.80 |
|  | SPER16H            | ER 16               | 4.00 |
|  | SPER20H            | ER 20               | 4.20 |









**OZ SPANNER DIN 6388 / ISO 10897 - OZ Ay Anahtar DIN 6388 / ISO 10897**

|                                                                                   | CODE / KOD<br>NER | TYPE / TİP  | EURO  |
|-----------------------------------------------------------------------------------|-------------------|-------------|-------|
|  | SPOZ12            | DIN6388D-12 | 7.50  |
|  | SPOZ16            | DIN6388D-16 | 7.50  |
|  | SPOZ20            | DIN6388D-12 | 7.50  |
|  | SPOZ25            | DIN6388D-25 | 5.30  |
|  | SPOZ32            | DIN6388D-32 | 13.50 |





**SPANNERS FOR SK COLLETS CHUCKS**  
SK Pens Başlıkları için Anahtarlar (Rulmanlı)

|                                                                                     | CODE / KOD<br>SPSK                                                                         | SK SIZE Ø / SK Ölçüsü Ø | Ø / D | EURO  |
|-------------------------------------------------------------------------------------|--------------------------------------------------------------------------------------------|-------------------------|-------|-------|
|   | SPSK06   | SK06                    | Ø19.5 | 24.00 |
|  | SPSK10  | SK10                    | Ø27   | 26.00 |
|  | SPSK13  | SK13                    | Ø33   | 28.00 |
|  | SPSK16  | SK16                    | Ø40   | 30.00 |
|  | SPSK20  | SK20                    | Ø55   | 36.00 |







**HSK63A COOLANT TUBE SPANNER / HSK63A Soğutucu Borusu Anahtarı**



|                                                                                     | CODE / KOD<br>SPHSK                                                                          | HOLDER TYPE<br>Tutucu Tipi | EURO  |
|-------------------------------------------------------------------------------------|----------------------------------------------------------------------------------------------|----------------------------|-------|
|  | SPHSK63                                                                                      | HSK63A                     | 14.50 |
|  | SPHSK100  | HSK100                     | 18.50 |



**FACE MILL SPANNER / ALIN FREZE TUTUCU ANAHTARI**



|                                                                                     | CODE / KOD<br>NER | TYPE / TİP | EURO  |
|-------------------------------------------------------------------------------------|-------------------|------------|-------|
|  | SPFM16            | FM16       | 12.00 |
|  | SPFM22            | FM22       | 13.00 |
|  | SPFM27            | FM27       | 14.50 |
|  | SPFM32            | FM32       | 17.50 |
|  | SPFM40            | FM40       | 24.50 |

**HP HOLDER SPANNER / HP Tutucu Anahtarı**

|                                                                                  | CODE / KOD<br>SPER | HOLDER TYPE<br>Tutucu Tipi | EURO  |
|----------------------------------------------------------------------------------|--------------------|----------------------------|-------|
|  | SPHP20             | HP20                       | 13.00 |
|  | SPHP25             | HP25                       | 13.00 |
|  | SPHP32             | HP32                       | 14.50 |



**ER HIGH SPEED NUT SPANNER / ER Yüksek Hız Somunu Anahtarı**

|                                                                                  | CODE / KOD<br>SPER | ER NUT TYPE<br>ER Somun Tipi | EURO  |
|----------------------------------------------------------------------------------|--------------------|------------------------------|-------|
|  | SPER11HS           | NER11HS                      | 16.00 |
|  | SPER16HS           | NER16HS                      | 16.50 |
|  | SPER20HS           | NER20HS                      | 17.50 |





**EXTRACTION SPANNER FOR HYDRAULIC REDUCTION COLLET  
HİDROLİK Redüksiyon Pensi Çıkarma Anahtarı**

|                                                                                    | CODE / KOD<br>SPER | SUITABLE FOR COLLETS<br>Uyumlu Pensler | EURO  |
|------------------------------------------------------------------------------------|--------------------|----------------------------------------|-------|
|  | SPRH               | RH12 - RH20<br>RH25 - RH32             | 18.00 |







**DRILL CHUCK SPANNER / Mandren Anahtarı**

|                                                                                    | CODE / KOD<br>SPER | HOLDER TYPE<br>Tutucu Tipi | EURO  |
|------------------------------------------------------------------------------------|--------------------|----------------------------|-------|
|  | SPDC13             | DC13                       | 12.50 |
|  | SPDC16             | DC16                       | 13.50 |
|  | SPDC20             | DC20                       | 17.00 |











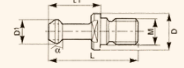

**TAPER CLEANER / Konik Temizleyici**

|                                                                                    | CODE / KOD | Description / Tanımı | EURO  |
|------------------------------------------------------------------------------------|------------|----------------------|-------|
|  | TCL30      | TAPER CLEANER SK30   | 6.50  |
|  | TCL40      | TAPER CLEANER SK40   | 7.00  |
|  | TCL50      | TAPER CLEANER SK50   | 8.00  |
|  | TCLHSK63   | TAPER CLEANER HSK63  | 11.50 |
|  | TCLHSK100  | TAPER CLEANER HSK100 | 18.00 |









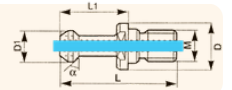

**MAS 403 BT without coolant hole**  
Soğutma deliksiz



|                                                                                   | CODE / KOD<br>PSBT | Toolholder Taper<br>Tutucu Konik | M   | D    | D1 | L  | L1 | $\alpha$ | EURO |
|-----------------------------------------------------------------------------------|--------------------|----------------------------------|-----|------|----|----|----|----------|------|
|  | PSBT3045           | BT30                             | M12 | 16.5 | 11 | 43 | 23 | 45°      | 3.80 |
|  | PSBT3060           | BT30                             | M12 | 16.5 | 11 | 43 | 23 | 60°      | 3.80 |
|  | PSBT3090           | BT30                             | M12 | 16.5 | 11 | 43 | 23 | 90°      | 3.80 |
|  | PSBT4045           | BT40                             | M16 | 23   | 15 | 60 | 35 | 45°      | 3.80 |
|  | PSBT4060           | BT40                             | M16 | 23   | 15 | 60 | 35 | 60°      | 3.80 |
|  | PSBT4090           | BT40                             | M16 | 23   | 15 | 60 | 35 | 90°      | 3.80 |
|  | PSBT5045           | BT50                             | M24 | 38   | 23 | 85 | 45 | 45°      | 5.50 |
|  | PSBT5060           | BT50                             | M24 | 38   | 23 | 85 | 45 | 60°      | 5.50 |
|  | PSBT5090           | BT50                             | M24 | 38   | 23 | 85 | 45 | 90°      | 5.50 |



**MAS 403 BT - Internal coolant**  
İçten soğutma delikli



|                                                                                     | CODE / KOD<br>PSBT | Toolholder Taper<br>Tutucu Konik | M   | D    | D1 | L  | L1 | $\alpha$ | EURO |
|-------------------------------------------------------------------------------------|--------------------|----------------------------------|-----|------|----|----|----|----------|------|
|  | PSBT3045B          | BT30                             | M12 | 16.5 | 11 | 43 | 23 | 45°      | 4.20 |
|  | PSBT4045B          | BT40                             | M16 | 23   | 15 | 60 | 35 | 45°      | 4.20 |
|  | PSBT4060B          | BT40                             | M16 | 23   | 15 | 60 | 35 | 60°      | 4.20 |
|  | PSBT4090B          | BT40                             | M16 | 23   | 15 | 60 | 35 | 90°      | 4.20 |
|  | PSBT5045B          | BT50                             | M24 | 38   | 23 | 85 | 45 | 45°      | 6.00 |
|  | PSBT5060B          | BT50 <b>NEW</b>                  | M24 | 38   | 23 | 85 | 45 | 60°      | 6.00 |
|  | PSBT5090B          | BT50 <b>NEW</b>                  | M24 | 38   | 23 | 85 | 45 | 90°      | 6.00 |

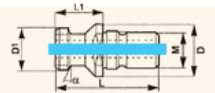

**DIN 69872A - Internal coolant**  
İçten soğutma delikli

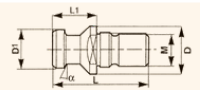

|                                                                                     | CODE / KOD<br>PSBT   | Toolholder Taper<br>Tutucu Konik | M   | D  | D1 | L  | L1 | $\alpha$ | EURO |
|-------------------------------------------------------------------------------------|----------------------|----------------------------------|-----|----|----|----|----|----------|------|
|  | PS698723A            | DIN30 (69871)                    | M12 | 17 | 13 | 44 | 24 | 15°      | 4.20 |
|  | PS698724B <b>NEW</b> | DIN69872A                        | M16 | 23 | 19 | 55 | 29 | 15°      | 4.90 |
|  | PS698724A            | DIN40 (69871)                    | M16 | 23 | 19 | 54 | 26 | 15°      | 4.20 |
|  | PS698725A            | DIN50 (69871)                    | M24 | 36 | 28 | 74 | 34 | 15°      | 6.00 |

**DIN 69872B without coolant hole**  
Soğutma deliksiz



|                                                                                     | CODE / KOD<br>PSBT | Toolholder Taper<br>Tutucu Konik | M   | D  | D1 | L  | L1 | $\alpha$ | EURO |
|-------------------------------------------------------------------------------------|--------------------|----------------------------------|-----|----|----|----|----|----------|------|
|  | PS698724B          | DIN40 (69871)                    | M16 | 23 | 19 | 54 | 26 | 15°      | 3.80 |
|  | PS698725B          | DIN50 (69871)                    | M24 | 36 | 28 | 74 | 34 | 15°      | 5.50 |

**PULL STUDS**  
Çektirme Civataları

**ISO 7388/2 (1984/B) - Internal coolant**  
İçten soğutma delikli

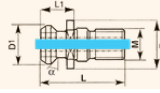

|  | CODE / KOD<br>PSBT | Toolholder Taper<br>Tutucu Konik | M   | D    | D1   | L    | L1    | $\alpha$ | EURO |
|--|--------------------|----------------------------------|-----|------|------|------|-------|----------|------|
|  | PS738840A          | DIN40 (69871)                    | M16 | 22.5 | 18.9 | 44.5 | 16.25 | 45°      | 4.20 |
|  | PS738850A          | DIN50 (69871)                    | M24 | 36   | 29.1 | 65.5 | 25.55 | 45°      | 6.00 |



**ISO 7388/2 (1984/B) - without coolant hole**  
Soğutma deliksiz

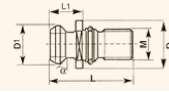

|  | CODE / KOD<br>PSBT | Toolholder Taper<br>Tutucu Konik | M   | D    | D1   | L    | L1    | $\alpha$ | EURO |
|--|--------------------|----------------------------------|-----|------|------|------|-------|----------|------|
|  | PS738840B          | DIN40 (69871)                    | M16 | 22.5 | 18.9 | 44.5 | 16.25 | 45°      | 3.80 |
|  | PS738850B          | DIN50 (69871)                    | M24 | 36   | 29.1 | 65.5 | 25.55 | 45°      | 5.50 |



**FOR MAZAK MACHINES - Internal coolant**  
MAZAK Tezgahlar için - İçten soğutma delikli

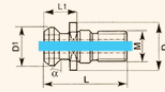

|  | CODE / KOD<br>PSBT            | Toolholder Taper<br>Tutucu Konik | M   | D  | D1   | L    | L1   | $\alpha$ | EURO |
|--|-------------------------------|----------------------------------|-----|----|------|------|------|----------|------|
|  | PS738840MZ                    | DIN40 (69871)                    | M16 | 22 | 18.8 | 44.1 | 19.1 | 45°      | 4.90 |
|  | PS738850MZ <small>NEW</small> | DIN50 (69871)                    | M16 | 22 | 18.8 | 44.1 | 19.1 | 45°      | 6.00 |



**SK30 FOR CNC ROUTER MACHINES**  
SK30 CNC ROUTER Tezgahlar için

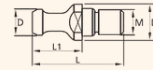

|  | CODE / KOD<br>PSBT | Toolholder Taper<br>Tutucu Konik | M   | D  | D1 | L  | L1 | $\alpha$ | EURO |
|--|--------------------|----------------------------------|-----|----|----|----|----|----------|------|
|  | PSSK30             | SK30                             | M12 | 17 | 12 | 44 | 24 | R        | 5.00 |





Gürkan Makina Tic. ve San. Ltd.Şti.  
Metal-İş San. Sit. 9.Bl. No:18 İkitelli OSB.  
Başakşehir 34490 İstanbul / TÜRKİYE  
Tel: +90 212 5493424 info@gurkan.com  
[www.gurkan.com](http://www.gurkan.com)